

# márlín

---

1

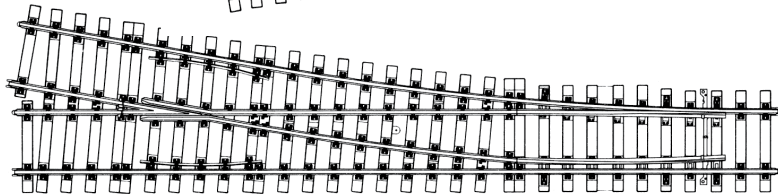
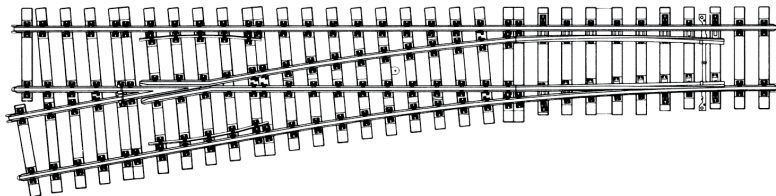

Weiche  
59083/59084

<b>Inhaltsverzeichnis</b>	Seite
Lieferumfang	4
Sicherheitshinweise	5
Wichtige Hinweise	5
Funktionen	5
Decoder-Einbau	6
Entsorgung	6
Garantie	6
CV Programmierung	7
Vorbereitung und Aufbau	23
Programmier-Tabellen	29

<b>Sommaire</b>	Page
Matériel fourni	4
Consignes de sécurité	11
Indications importantes	11
Fonctions	11
Installation du décodeur	12
Elimination	12
Garantie	12
Programmation des CV	13
Préparation et Construction	23
Tableau de programmation	29

<b>Table of Contents</b>	Page
Contents as Delivered	4
Safety Notes	8
Important Information	8
Functions	8
Decoder Installation	9
Disposal	9
Warranty	9
CV Programming	10
Preparation and Building	23
Programming Table	29

<b>Inhoudsopgave</b>	Pagina
Leveringsomvang	4
Veiligheidsvoorschriften	14
Belangrijke aanwijzingen	14
Werking	14
Decoder inbouwen	15
Afdanken	15
Garantie	15
CV-programmering	16
Vorbereitung en Structuur	23
Programmeertabel	29

<b>Índice</b>	<b>Página</b>
Alcance de suministro	4
Instrucciones de seguridad	17
Notas importantes	17
Funciones	17
Montaje del decoder	18
Eliminación	18
Garantía	18
Programación de variables CV	19
Preparación y construcción	23
Tabla de programación	29

<b>Elenco del contenuto</b>	<b>Pagina</b>
Corredo di fornitura	4
Avvertenze di sicurezza	20
Avvertenze importanti	20
Funzioni	20
Montaggio del Decoder	21
Smaltimento	21
Garanzia	21
Programmazione delle CV	22
Preparazione e costruzione	23
Tabella di programmazione	29

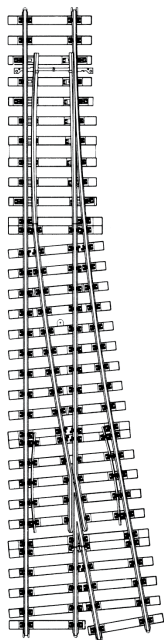

**Digital Decoder**  
**Digital decoder**  
**Le décodeur numérique**  
**Digitaal-decoder**  
**Decoder digital**  
**Decoder Digital**

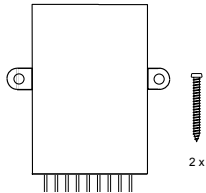

**Stellhebel und Weichenlaterne • Switch lever and turnout lantern • Levier de commande et lanterne d'aiguille • Wisselhandel en wissellantaarn • Palanca de mando y farol de aguja • Leva di azionamento e lanterna per deviatò**

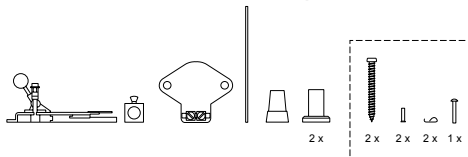

**Weichenmotor • Turnout motor • Moteur d'aiguille • Wisselsteller • Motor de agujas • Motore per deviatò**

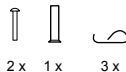
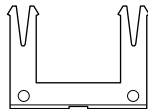
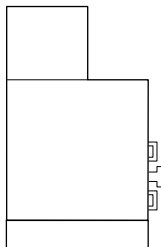

## Sicherheitshinweise

- **ACHTUNG!** Funktionsbedingte scharfe Kanten und Spitzen.
- Darf nur in trockenen Räumen verwendet werden.
- Verkabelungs- und Montagearbeiten nur im spannungslosen Zustand ausführen. Bei Nichtbeachtung kann es zu gefährlichen Körperströmen und damit zu Verletzungen führen.
- **Decoder nur mit der zulässigen Spannung** (siehe technische Daten) **betreiben**.



Beim Umgang mit dem LötKolben besteht die Gefahr von **Hautverbrennungen**.

## Wichtige Hinweise

- Für den Einbau zusätzlich benötigtes Werkzeug: Pinzette und Lötstation für eine Löttemperatur bis max. 30W/300° mit dünner Spitze, Elektronik-Lötzinn (Ø 0,5-1 mm), Entlötlitze oder Entlötsaugpumpe.
- **Achtung:** Beim Einbau möglichst keine Bauteile auf der Oberseite des Einbau-Digital-Decoders berühren, statische Aufladung kann die Funktion beeinträchtigen.
- Die Bedienungsanleitung ist Bestandteil des Produktes und muss deshalb aufbewahrt sowie bei Weitergabe des Produktes mitgegeben werden.
- Für Reparaturen wenden Sie sich bitte an Ihren Märklin-Fachhändler.
- Entsorgung: [www.maerklin.com/en/imprint.html](http://www.maerklin.com/en/imprint.html)

## Technische Daten

- Belastung Weichenausgang max. 300 mA
- Spannung Digitalstromkreis max. 20 V eff.
- Spannungsfestigkeit max. 40 V

## Funktionen

- Multiprotokoll fähig: fx (MM) und DCC
- Einstellen der Betriebsart mittels DIP-Schalter
- Einstellbare Adressen mit DIP-Schalter:  
**1-256** fx (MM) (Control Unit 6021/Mobile Station 60651/652)  
**1-320** fx (MM) (Central Station 6021x/Mobile Station 60653)  
**1-511** (DCC)
- Programmierbare Adressen über CV →   
**1-2044** DCC
- Änderungen der Eigenschaften über CV
- Stromversorgung über Digitalstromkreis

## Decoder-Einbau

Änderungen der Eigenschaften im fx (MM)-Protokoll durch CV Programmierung oder zur DCC CV-Programmierung folgen Sie dem Kapitel „CV Programmierung.“

**Folgende Arbeitsschritte dürfen nur im spannungslosen Zustand ausgeführt werden:**

**Beachten Sie**, dass Einstellungen mit dem DIP-Schalter immer spannungslos vorzunehmen sind. Der Einbau-Digital-Decoder erkennt erst mit dem Einschalten der Spannung die aktuellen Schalterstellungen.

Einbau des Einbau-Digital-Decoders in Märklin-Weiche siehe Seite 23.

Ab Seite 29 finden Sie die Tabelle für die Adressierung mit DIP-Schalter.

## Entsorgung

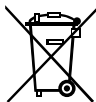

Hinweise zum Umweltschutz: Produkte, die mit dem durchgestrichenen Mülleimer gekennzeichnet sind, dürfen am Ende ihrer Lebensdauer nicht über den normalen Haushaltsmüll entsorgt werden, sondern müssen an einem Sammelpunkt für das Recycling von elektrischen und elektronischen Geräten abgegeben werden. Das Symbol auf dem Produkt, der Bedienungsanleitung oder der Verpackung weist darauf hin. Die Werkstoffe sind gemäß ihrer Kennzeichnung wiederverwertbar. Mit der Wiederverwendung, der stofflichen Verwertung oder anderen Formen der Verwertung von Altgeräten leisten Sie einen wichtigen Beitrag zum Schutze unserer Umwelt. Bitte erfragen Sie bei Ihrer Gemeindeverwaltung die zuständige Entsorgungsstelle.

## Garantie

Gewährleistung und Garantie gemäß der beiliegenden Garantieurkunde.

- Für Reparaturen wenden Sie sich bitte an Ihren Märklin-Fachhändler oder an  
Gebr. Märklin & Cie. GmbH  
Reparaturservice  
Stuttgarter Str. 55 - 57  
73033 Göppingen  
Germany  
Tel: 07161 608 222  
E-Mail: Service@maerklin.de

## CV Programmierung

Die CV Programmierung muss am Programmiergleis erfolgen. Für die Programmierung empfehlen wir, eine fiktive Lokomotive anzulegen. Werte in Klammern sind die Werkseinstellungen.

Während der Datenübertragung blinkt zur Kontrolle die am Einbau-Digital-Decoder angeschlossene Weichenlaterne.

### fx (MM)

Vor der Programmierung muss die zu programmierende Weiche mit dem Keyboard geschaltet werden. Danach unverzüglich mit der Control Unit bzw. CV Konfiguration der Central Station die CV geändert werden. Danach sofort die programmierte Weiche wieder mit dem Keyboard schalten. Erst jetzt ist die Programmierung übernommen und wirksam.

CV	Bedeutung	Werte	
8	Decoder-Reset	8 (-)	Werkseinstellung, Wert wird nicht geschrieben
37	Stellweg umkehren	0-1 (0)	Ändert die Schaltrichtung

Die Vorgehensweise beim Programmieren mit der Control Unit 6021 entspricht der Lokprogrammierung ([www.maerklin.de](http://www.maerklin.de) -> Tools & Downloads -> Technische Informationen).

## DCC

CV	Bedeutung	Werte	
1	Adresse, niederwertige Byte	0-255 (1)	
7	Hersteller Versionsnummer (Softwareversion)	(-)	nur lesen
8	Hersteller Kennung ID Decoder Reset	(131) 8 (-)	nur lesen, Werkseinstellung, Wert wird nicht geschrieben
9	Adresse, höherwertige Byte	0-7 (0)	
29	Konfiguration	(192)	nur lesen
	Bit 0-4 werden nicht verwendet	0	
	Bit 5: Decodertyp	0 / 32	Basis- o. erweiterter Zubehördecoder
	Bit 6: Adressierungsmethode	0 / 64	Decoder- o. Ausgangsadresse
	Bit 7: Decoderart	128	Zubehördecoder
37	Stellweg umkehren	0-1 (0)	Ändert die Schaltrichtung

### Einstellen und errechnen der Adressen größer 255:

Z.B. Adresse 1044 ->  $1044:256=4,078125$ . Der Wert vor dem Komma (4) ist in CV 9 einzutragen. Den Wert nach dem Komma (0,078125) wird mit 256 multipliziert  $0,078125 \times 256=20$ . Der errechnete Wert 20 muss in CV 1 eingetragen werden.

## Safety Notes

- **IMPORTANT!** This product has sharp edges and points related to its function.
- This decoder may only be used in dry areas indoors.
- Do wiring and assembly work only in a voltage-free work environment. Otherwise you may experience electrical current dangerous to the body leading to injury.
- **Operate this decoder only with the permissible voltage** (see technical information).



When using a solder station there is the danger of **burning your skin.**

## Important Information

- Additional tools required for installation: tweezers and soldering station for a maximum soldering temperature of 30 watts / 300° Celsius / 572° Fahrenheit with a fine point, Electronic solder (0.5-1 mm dia.), desoldering braid or desoldering pump.
- **Important:** When installing the digital installation decoder, try to avoid touching components on the upper side of the decoder. Static charge can affect the function of the decoder.
- The operating instructions are a component part of the product and must therefore be kept with the product, particularly when it is given to another party.
- For repairs please see your authorized Märklin specialty dealer.
- Disposing: [www.maerklin.com/en/imprint.html](http://www.maerklin.com/en/imprint.html)

## Technical Data

- Load at turnout output max. 300 amps
- Voltage for the digital power circuit max. 20 volts eff.
- Electrical strength max. 40 volts

## Functions

- Capable of multi-protocols: fx (MM) and DCC
- Mode of operation set with DIP switches
- Addresses can be set with DIP switches:
  - 1-256 fx (MM) (Control Unit 6021/Mobile Station 60651/652)
  - 1-320 fx (MM) (Central Station 6021x/Mobile Station 60653)
  - 1-511 (DCC)
- Programmable addresses using CVs → 
- Changes to characteristics can be done with CVs
- Power supply done using the digital power circuit



## Decoder Installation

See the section “CV Programming” for changes to other characteristics in the fx (MM) protocol using CV programming or to the DCC CV programming.

**The following work steps may only be done in a voltage-free work environment:**

**Note:** Settings with the DIP switches are to be only when the voltage is turned off. The digital installation decoder does not recognize the current switch settings until the voltage is turned on.

See page 23 for installation of the digital installation decoder in Märklin standard turnouts, curved turnouts, or double slip switches.

Starting on page 29 you'll find the table for setting addresses with DIP switches.

## Disposal

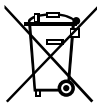

Information about protecting the environment: Products marked with a trashcan with a line through it may not be disposed of at the end of their useful life along with the normal household trash. They must be taken to a collection point for recycling electrical and electronic devices. The symbol on the product, the instructions, or the packaging indicates this. Depending on their description, the raw materials can be used again. You make an important contribution to the protection of our environment with the recycling of this material from old devices. Please inquire in your community about the appropriate disposal site.

## Warranty

The warranty terms are stated on the warranty card included with this product.

- U.S. only:  
Märklin, Inc.  
PO Box 510559  
New Berlin WI 53151  
Phone: 262-522-7080  
Fax: 262-522-7288  
Email: [info@marklin.com](mailto:info@marklin.com)

Technical Hotline

Contacts: Curtis Jeung & Rick Sinclair, Digital Consultants

Telephone: 650-569-1318

Hours: 6:00am – 9:00pm PST, Monday through Friday

E-mail: [digital@marklin.com](mailto:digital@marklin.com)

- GB only  
Gebr. Märklin & Cie. GmbH  
Reparaturservice  
Stuttgarter Str. 55 - 57  
73033 Göppingen  
Germany  
Tel: +49 7161 608 222  
E-Mail: [Service@maerklin.de](mailto:Service@maerklin.de)

## CV Programming

CV programming must be done on the programming track. We recommend creating a fictitious locomotive for programming purposes. Values in parentheses are the factory settings.

The turnout lantern connected to the digital installation decoder will blink as a control check during the data transmission.

### fx (MM)

Before doing any programming, the turnout to be programmed must be switched with the Keyboard. After that the CVs are changed immediately with the Control Unit or the CV configuration on the Central Station. After that the programmed turnout is to be switched again with the Keyboard. At this point the programming is accepted and is functional.

CV	Meaning	Values	
8	Decoder reset	8 (-)	factory setting, not written value is
37	Reverse travel range	0-1 (0)	Changes the electrical switching direction

The procedure for programming with the 6021 Control Unit is the same as locomotive programming ([www.maerklin.de](http://www.maerklin.de) -> Tools & Downloads -> Technische Informationen).

## DCC

CV	Meaning	Values	
1	Address, lower value Byte	0-255 (1)	
7	Manufacturer version number (software version)	(-)	read only
8	Manufacture recognition ID Decoder reset	(131) 8 (-)	read only, factory setting, value is not written
9	Address, higher value Byte	0-7 (0)	
29	Configuration	(192)	read only
	Bits 0-4 are not used	0	
	Bit 5: Decoder type	0 / 32	basic or advanced accessory decoder
	Bit 6: Addressing method	0 / 64	decoder or output address
	Bit 7: Decoder type	128	accessory decoder
37	Reverse travel range	0-1 (0)	Changes the electrical switching direction

### Setting and generating addresses larger than 255:

Example: Address 1044 -> 1044:256=4,078125. The value before the comma (4) is to be entered in CV 9. The value after the comma (0,078125) is multiplied by 256, 078125x256=20. The value of 20 that is generated must be entered in CV 1.

## Consignes de sécurité

- **ATTENTION !** L'appareil présente des arêtes coupantes.
- A utiliser exclusivement dans des pièces sèches.
- Câblage et montage doivent être réalisés uniquement quand l'appareil est hors tension. Le non respect de ces consignes peut générer des courants de choc dangereux et être à l'origine de blessures.
- **Exploiter le décodeur uniquement avec la tension autorisée** (voir caractéristiques techniques).



Risques de **brûlures** lors de la manipulation du fer à souder.

## Indications importantes

- Outils nécessaires à l'installation : Pincette et poste à souder pour une température de brasage maximale de 30 W/300° avec pointe fine, fil à souder pour électronique (Ø 0,5-1 mm), tresse à dessouder ou pompe à dessouder.
- **Attention :** Lors de l'installation, éviter dans la mesure du possible de toucher les composants situés sur la face supérieure du décodeur numérique, une charge statique pouvant entraver le fonctionnement.
- La notice d'utilisation fait partie intégrante du produit ; elle doit donc être conservée et, le cas échéant, transmise avec le produit.
- Pour toute réparation, adressez-vous SVP à votre détaillant spécialisé Märklin.
- Elimination : [www.maerklin.com/en/imprint.html](http://www.maerklin.com/en/imprint.html)

## Caractéristiques techniques

- Charge sortie aiguille max. 300 mA
- Tension circuit numérique max. 20 V eff.
- Tenue en tension max. 40 V

## Fonctions

- multi protocole: fx (MM) et DCC
- Définition du mode d'exploitation via commutateur DIP
- Définition des adresses possible via commutateur DIP :  
**1-256** fx (MM) (Control Unit 6021/Mobile Station 60651/652)  
**1-320** fx (MM) (Central Station 6021x/Mobile Station 60653)  
**1-511** (DCC)
- Adresses programmables via CV →   
**1-2044** DCC
- Modifications des propriétés via CV
- Alimentation en courant via circuit numérique

## Installation du décodeur

Pour modifier les autres caractéristiques dans le protocole fx (MM) via la programmation des CV ou pour la programmation des CV dans le protocole DCC, veuillez suivre les indications du chapitre « Programmation des CV ».

**L'installation, dont les différentes étapes sont décrites ci-dessous, doit impérativement être réalisée hors tension :**

**Attention :** Les paramétrages avec le commutateur DIP doivent toujours se faire hors tension. Le décodeur numérique ne reconnaît les nouvelles positions du commutateur qu'à la mise sous tension.

Installation du décodeur numérique dans les aiguillages Märklin : voir page 23.

Vous trouverez le tableau pour la définition des adresses avec commutateur DIP à partir de la page 29.

## Élimination

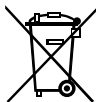

Indications relatives à la protection de l'environnement : Les produits marqués du signe représentant une poubelle barrée ne peuvent être éliminés en fin de vie via les ordures ménagères normales, mais doivent être remis à un centre de collecte pour le recyclage des appareils électriques et électroniques. Le symbole figurant sur le produit lui-même, la notice d'utilisation ou l'emballage l'indique. Les matériaux sont recyclables selon leur marquage. Avec le recyclage, la récupération des matériaux ou autres formes de valorisation de vieux appareils, vous contribuez sensiblement à la protection de notre environnement. Renseignez-vous auprès de votre municipalité sur les centres compétents pour le traitement des déchets.

## Garantie

Garantie légale et garantie contractuelle conformément au bon de garantie ci-joint.

- Pour toute réparation, veuillez vous adresser à votre détaillant spécialisé Märklin ou à  
Gebr. Märklin & Cie. GmbH  
Reparaturservice  
Stuttgarter Str. 55 - 57  
73033 Göppingen  
Germany  
Tél: +49 7161 608 222  
e-mail : Service@maerklin.de

## Programmation des CV

La programmation des CV se fait sur la voie de programmation. Pour la programmation, nous vous conseillons de créer une locomotive fictive. Les valeurs indiquées entre parenthèses correspondent aux paramètres d'usine.

Durant la transmission des données, la lanterne d'aiguille raccordée au décodeur numérique clignote (contrôle).

### fx (MM)

Avant de procéder à la programmation, commutez l'aiguille à programmer via le Keyboard. Modifiez ensuite sans attendre la CV avec la Control Unit, respectivement via la fonction de configuration des CV de la Central Station. Commutez alors à nouveau et immédiatement l'aiguille programmée via le Keyboard. La programmation est enfin enregistrée et effective.

CV	Signification	Valeurs	
8	Réinitialisation du décodeur	8 (-)	Paramètre d'usine, la valeur n'est pas enregistrée
37	Inverser la course de manœuvre	0-1 (0)	Modifie le sens de commutation

La procédure à suivre pour la programmation avec la Central Unit 6021 correspond à la programmation de la loco ([www.maerklin.de](http://www.maerklin.de) -> Tools & Downloads -> Technische Informationen).

## DCC

CV	Signification	Valeurs	
1	Adresse, octet de valeur basse	0-255 (1)	
7	Numéro de version fabricant (version logicielle)	(-)	Lire uniquement
8	Identifiant du fabricant Réinitialisation du décodeur	(131) 8 (-)	Lire uniquement, paramètre d'usine, la valeur n'est pas enregistrée
9	Adresse, octet de valeur supérieure	0-7 (0)	
29	Configuration	(192)	Lire uniquement
	Bits 0 à 4 non utilisés	0	
	Bit 5: Type de décodeur	0 / 32	Décodeur d'accessoires de base ou avancé
	Bit 6: Méthode d'adressage	0 / 64	Adresse du décodeur ou adresse de départ
	Bit 7: Type de décodeur	128	Décodeur d'accessoires
37	Inverser la course de manœuvre	0-1 (0)	Modifie le sens de commutation

### Définition et calcul des adresses supérieures à 255 :

Par ex. Adresse 1044 ->  $1044:256=4,078125$ . La valeur avant la virgule (4) est à reporter dans la CV 9. La valeur située après la virgule (0,078125) est multipliée par 256  $0,078125 \times 256=20$ . La valeur calculée 20 est à reporter dans la CV 1.

## Veiligheidsvoorschriften

- **Let op!** bevat vanwege zijn functie scherpe randen en punten.
- Mag alleen in droge ruimtes gebruikt worden.
- Bedrading- en montage alleen in spanningloze toestand uitvoeren. Bij het niet naleven kunnen er gevaarlijke stromen door het lichaam vloeien en verwondingen ontstaan.
- **Decoder alleen met de toegelaten spanning** (zie technische gegevens) **gebruiken**.



Bij het werken met een soldeerbout bestaat het gevaar voor **brandwonden**.

## Belangrijke aanwijzingen

- Voor het inbouwen is het volgende gereedschap nodig: pincet en soldeerstation met een maximale temperatuur van 30 W/300° C met een dunne stift, elektronica soldeert in (0.5 - 1mm), desoldeerlitze of soldeertinzuiger.
- **Let op:** bij het inbouwen de delen op de bovenzijde van de inbouw-digitaaldecoder niet aanraken, statische ontlading kan de juiste werking beïnvloeden.
- De gebruiksaanwijzing is onderdeel van het product en moet derhalve bij de overdracht van het product meegegeven worden.
- Voor reparaties kunt u zich tot uw Märklin dealer wenden.
- Afdanken: [www.maerklin.com/en/imprint.html](http://www.maerklin.com/en/imprint.html)

## Technische gegevens

- Belasting wisseluitgang max. 300 mA
- Spanning digitale stroomkring max. 20 V eff.
- Diëlektrische sterkte max. 40 V

## Werking

- Multiprotocol: fx (MM) en DCC
- Instellen van het bedrijfssysteem met DIP-schakelaar
- Instellen van het adres met DIP-schakelaar
  - 1-256** fx (MM) (Control Unit 6021/Mobile Station 60651/652)
  - 1-320** fx (MM) (Central Station 6021x/Mobile Station 60653)
  - 1-511** (DCC)
- Programmeerbare adressen via CV → 
- **1-2044** DCC
- Wijzigen van de eigenschappen via CV
- Stroomvoorziening via digitale stroomkring

## Decoder inbouwen

Veranderen van de te wijzigende eigenschappen in het fx (MM) protocol door CV programmering of het DCC CV programmering vindt u in het hoofdstuk "CV programmering".

### **De volgende stappen mogen alleen in spanningloze toestand uitgevoerd worden:**

**Let op:** instellingen van de DIP-schakelaars alleen in spanningloze toestand uitvoeren. De inbouw-digitaaldecoder herkent de actuele schakelaarstand pas na het inschakelen van de voedingsspanning.

Inbouw van de inbouw-digitaaldecoder in de Märklin wissels zie pagina 23.

Vanaf pagina 29 vindt u de tabel voor de adressering met de DIP-schakelaars.

## Afdanken

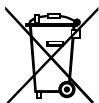

Milieu-informatie: producten, die met de doorgestreepte afvalcontainer zijn gemarkeerd, mogen aan het einde van hun levensduur niet met het normale huisvuil meegegeven worden, maar moeten op een verzamelpunt voor de recycling van elektrische en elektronische apparatuur afgegeven worden. Het symbool op het product, op de handleiding of op de verpakking geeft dit aan. De materialen worden gerecycled in overeenstemming met hun identificatie. Met het hergebruik van de grondstoffen of andere vormen van het hergebruik van oude apparatuur levert u een belangrijke bijdrage aan de bescherming van ons milieu. Neem contact op met uw gemeente voor een bevoegde plaatselijke inzamelplaats.

## Garantie

Waarborg en garantie volgens bijgevoegd garantiebewijs.

- Voor reparaties kunt u zich wenden tot uw Märklin dealer of tot  
Gebr. Märklin & Cie. GmbH  
Reparaturservice  
Stuttgarter Str. 55 - 57  
73033 Göppingen  
Germany  
Tel: +49 7161 608 222  
E-Mail: [Service@maerklin.de](mailto:Service@maerklin.de)

## CV Programmering

De CV programmering moet via het programmeerspoor gebeuren. Voor het programmeren is het aan te bevelen een fictive loc aan te maken. De waarden tussen haakjes zijn de af fabriek ingestelde waarden.

Tijdens de dataoverdracht knippert, ter controle, de aan de inbouw-digitaaldecoder aangesloten wisselantaarn.

### fx (MM)

Voor het programmeren moet de te programmeren wissel met het keyboard geschakeld worden. Daarna onmiddellijk met de Control Unit resp. via CV configuratie met het Central Station de CV wijzigen. Daarna direct de geprogrammeerde wissel met het keyboard schakelen. Pas dan is de programmering overgenomen en werkzaam.

CV	Omschrijving	Waarde	
8	Decoder reset	8 (-)	Fabrieksinstelling, waarde wordt niet geschreven
37	Stelrichting omkeren	0-1 (0)	Wijzigt de schakelrichting

De werkwijze bij het programmeren met de Control Unit 6021 komt overeen met het programmeren van een locomotief-decoder ([www.maerklin.de](http://www.maerklin.de) -> Tools & Downloads -> Technische Informatie(n)).

## DCC

CV	Omschrijving	Waarde	
1	Adres, lage byte	0-255 (1)	
7	Fabrikant versienummer (softwareversie)	(-)	alleen lezen
8	Fabrikant kenmerk ID decoder reset	(131) 8 (-)	alleen lezen, fabrieksinstelling, waarde wordt niet geschreven
9	Adres, hoge byte	0-7 (0)	
29	Configuratie	(192)	alleen lezen
	Bit 0-4 worden niet gebruikt	0	
	Bit 5: decodertype	0 / 32	Basis- of uitgebreide toebehoren decoder
	Bit 6: adresseringsmethode	0 / 64	Decoder of uitgangsadres
	Bit 7: decodertype	128	Toebehoren decoder
37	Stelrichting omkeren	0-1 (0)	Wijzigt de schakelrichting

### Instellen en berekenen van de adressen groter dan 255:

Bijv. adres 1044 ->  $1044:256=4,078125$ . De waarde voor de komma (4) moet in CV 9 ingevoerd worden. De waarde achter de komma (0,078125) wordt nu met 256 vermenigvuldigd  $0,078125 \times 256 = 20$ . De berekende waarde 20 moet in CV 1 ingevoerd worden.



## Instrucciones de seguridad

- **¡ATENCIÓN!** El diseño presenta aristas y puntas cortantes impuestas por las características funcionales.
- Su uso está permitido únicamente en recintos secos.
- Ejecutar los trabajos de cableado y montaje únicamente sin tensión. En el caso de inobservancia pueden producirse corrientes peligrosas a través del cuerpo y, por tanto, lesiones.
- **Utilizar el decoder únicamente con la tensión admisible** (véase Datos técnicos).



Al manejar el soldador pueden producirse **quemaduras de la piel**.

## Notas importantes

- Herramienta adicional necesaria para el montaje: Pinza y estación de soldadura para una temperatura de soldeo de máx. 30W/300° con punta fina, estaño de soldar para electrónica (Ø 0,5-1 mm), cordón de desoldeo o bomba aspiradora de desoldeo.
- **Atención:** En el montaje, a ser posible, no tocar componentes situados en el lado superior del decoder digital integrable ya que las cargas estáticas pueden perjudicar a su funcionamiento.
- Las instrucciones de empleo forman parte integrante del producto y, por este motivo, deben conservarse y entregarse al nuevo comprador en el caso de venta del mismo.
- Para reparaciones, por favor diríjase a su distribuidor especializado de Märklin.
- Eliminación: [www.maerklin.com/en/imprint.html](http://www.maerklin.com/en/imprint.html)

## Datos técnicos

- Carga por salida de desvío max. 300 mA
- Tensión de circuito digital máx. 20 V efi.
- Rigidez dieléctrica máx. 40 V

## Funciones

- Apto para múltiples protocolos: fx (MM) y DCC
- Configuración del modo mediante microinterruptor DIP
- Direcciones configurables mediante interruptor DIP:  
**1-256** fx (MM) (Control Unit 6021/Mobile Station 60651/652)  
**1-320** fx (MM) (Central Station 6021x/Mobile Station 60653)  
**1-511** (DCC)
- Direcciones programables mediante variables CV →  
 → **1-2044** DCC
- Modificación de las características mediante variables CV
- Alimentación eléctrica mediante circuito digital

## Montaje del decoder

En el capítulo “Programación de las CVs” se explican las modificaciones de las demás características en el protocolo fx (MM) mediante programaciones de variables CV o para la programación de variables CV en el protocolo DCC.

**Está permitido ejecutar las siguientes operaciones únicamente sin tensión.**

**Nota importante:** Realizar los ajustes con el microinterruptor DIP siempre sin tensión. El decoder digital integrable no reconoce las posiciones actuales de los microinterruptores hasta que no se enciende la alimentación eléctrica.

Para el montaje del decoder digital integrable en un desvío estándar, un desvío en curvas o una travesía de unión doble de Märklin, véase Página 23.

A partir de la página 29 encontrará la tabla para el direccionamiento con microinterruptores DIP.

## Eliminación

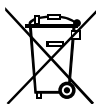

Instrucciones para protección del medio ambiente: Los productos identificados con el cubo de basura tachado no deben eliminarse junto con la basura doméstica normal y corriente una vez alcanzado el final de su vida útil, sino que deben entregarse en un punto de recogida para el reciclaje de equipos eléctricos y electrónicos. El símbolo que aparece en el producto, en las instrucciones de empleo o en el embalaje hace referencia a ello. Los materiales son reutilizables conforme a su identificación. Con la reutilización, el aprovechamiento de los materiales u otras formas de reciclado de aparatos viejos hacemos una aportación importante a la protección del medio ambiente. Consulte en su Ayuntamiento cuál es la entidad de recogida competente.

## Garantía

La garantía legal y la garantía del fabricante se basan en el documento de garantía adjunto.

- Para reparaciones, diríjase a su distribuidor profesional de Märklin-  
o a  
Gebr. Märklin & Cie. GmbH  
Reparaturservice  
Stuttgarter Str. 55 - 57  
73033 Göppingen  
Germany  
Tel: +49 7161 608 222  
E-Mail: Service@maerklin.de

## Programación de variables CV

La programación de variables CV debe realizarse en la vía de programación. Para la programación recomendamos crear una locomotora ficticia. Los valores entre paréntesis representan la configuración de fábrica.

Durante la transmisión de datos, para comprobación, destella el farol de aguja conectado al decoder digital integrable.

### fx (MM)

Antes de la programación, debe conmutarse con el Keyboard el desvío que se desee programar. Inmediatamente después debe modificarse la CV con la Control Unit o bien con la función Configuración de CV de la Central Station. A continuación, conmutar de nuevo inmediatamente el desvío programado. Hasta que esto no se haya hecho no se aplicará ni tendrá efecto la programación.

CV	Significado	Valores	
8	Reset de decoder	8 (-)	Configuración de fábrica, no se escribe el valor
37	Invertir el recorrido de enclavamiento	0-1 (0)	Cambia el sentido de maniobra

El procedimiento en la programación con la Central Unit equivale a la programación de locomotora ([www.maerklin.de](http://www.maerklin.de) -> Tools & Downloads -> Technische Informationen).

## DCC

CV	Significado	Valores	
1	Dirección, byte de menor peso	0-255 (1)	
7	Número de versión de fabricante (versión de software)	(-)	Sólo lectura
8	ID ident. de fabricante Reset de decoder	(131) 8 (-)	Sólo lectura, configuración de fábrica, no se escribe el valor
9	Dirección, byte de mayor peso	0-7 (0)	
29	Configuración	(192)	Sólo lectura
	Bit 0-4 No se utilizan los bits	0	
	Bit 5: Modelo de decoder	0 / 32	Decoder accesorio básico o ampliado
	Bit 6: Método de direccionamiento	0 / 64	Dirección de decoder o inicial
	Bit 7: Tipo de decoder	128	Decoder accesorio
37	Invertir el recorrido de enclavamiento	0-1 (0)	Cambia el sentido de maniobra

### Configuración y cálculo de las direcciones mayores que 255:

P. ej., dirección 1044 ->  $1044:256=4,078125$ . El valor antes de la coma (4) debe registrarse en la CV 9. El valor después de la coma (0,078125) se multiplica por 256  $0,078125 \times 256=20$ . El valor calculado 20 debe registrarse en CV 1.

## Avvertenze di sicurezza

- **ATTENZIONE!** Spigoli e punte affilati per necessità funzionale.
- Deve essere impiegato solamente in luoghi asciutti.
- Si eseguano i lavori di cablaggio e di montaggio solo in condizioni esenti da tensione. In caso di mancato rispetto questo può condurre a pericolose correnti nel corpo e di conseguenza a ferimenti.
- **Si faccia funzionare il Decoder solamente con la tensione ammissibile** (si vedano i dati tecnici).



Durante le operazioni con il saldatore sussiste il pericolo di **scottature della pelle**.

## Avvertenze importanti

- Attrezzi necessari in aggiunta per il montaggio: una pinzetta e una stazione di saldatura per una temperatura di saldatura sino a un max. di 30W/300° con una punta sottile, lega per saldature elettroniche (Ø 0,5-1 mm), trecciola dissaldante oppure pompa aspirante per dissaldare.
- **Attenzione:** durante il montaggio si tocchino il meno possibile i componenti sul lato superiore del Decoder Digital installabile, le cariche statiche possono compromettere la funzionalità.
- Le istruzioni di impiego costituiscono parte integrante del prodotto e devono pertanto venire conservate con cura nonché consegnate insieme in caso di cessione a terzi del prodotto.
- Per riparazioni Vi preghiamo di rivolgerVi al Vostro rivenditore specialista Märklin.
- Smaltimento: [www.maerklin.com/en/imprint.html](http://www.maerklin.com/en/imprint.html)

## Dati tecnici

- Carico dell'uscita per deviatori max. 300 mA
- Tensione nel circuito di corrente Digital max. 20 V eff.
- Rigidità dielettrica max. 40 V

## Funzioni

- Capacità multi-protocollo: fx (MM) und DCC
- Impostazione del tipo di funzionamento a mezzo commutatori DIP
- Indirizzi impostabili con commutatori DIP:  
**1-256** fx (MM) (Control Unit 6021/Mobile Station 60651/652)  
**1-320** fx (MM) (Central Station 6021x/Mobile Station 60653)  
**1-511** (DCC)
- Indirizzi programmabili tramite CV →   
**1-2044** DCC
- Modificazione delle caratteristiche tramite CV
- Alimentazione di corrente tramite circuito di corrente Digital

## Montaggio del Decoder

Per modificazioni delle altre caratteristiche nel protocollo fx (MM) mediante programmazione delle CV oppure per programmazione delle CV in DCC seguite il capitolo «Programmazione delle CV.»

**I seguenti passaggi del lavoro devono essere eseguiti solamente in condizioni esenti da tensione.**

**Prestate attenzione:** si intraprendano le impostazioni con il commutatore DIP sempre senza tensione. Il Decoder Digital installabile riconosce le attuali disposizioni del commutatore solo con l'attivazione della tensione.

Per il montaggio del Decoder Digital installabile in deviatore Märklin si veda a pagina 23.

A partire da pagina 29 potete trovare la tabella per l'indirizzamento con il commutatore DIP.

## Smaltimento

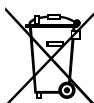

Avvertenze per la salvaguardia ambientale: i prodotti che sono contraddistinti con la pattumiera cancellata, alla fine della loro durata di vita non devono venire smaltiti tramite i normali rifiuti domestici, bensì devono venire conferiti ad un punto di raccolta per il riciclo di apparecchi elettrici ed elettronici. Tale simbolo sul prodotto, sulle istruzioni di impiego oppure sulla confezione dà avviso di questo. I materiali sono nuovamente utilizzabili in conformità al loro simbolo di riconoscimento. Con il riutilizzo, la valorizzazione dei materiali oppure altre forme di recupero degli apparecchi vecchi Voi fornite un importante contributo alla salvaguardia del nostro ambiente. Vi preghiamo di chiedere presso la Vostra amministrazione municipale i punti di smaltimento autorizzati.

## Garanzia

Prestazioni di garanzia e garanzie in conformità all'accluso certificato di garanzia.

- Per riparazioni Vi preghiamo di rivolgerVi al Vostro rivenditore specialista Märklin oppure a  
Gebr. Märklin & Cie. GmbH  
Reparaturservice  
Stuttgarter Str. 55 - 57  
73033 Göppingen  
Germany  
Tel: +49 7161 608 222  
E-Mail: Service@maerklin.de

## Programmazione delle CV

La programmazione delle CV deve avvenire sul binario di programmazione. Per tale programmazione noi consigliamo di inserire una locomotiva immaginaria. I valori tra parentesi sono le impostazioni di fabbrica.

Durante la trasmissione dei dati lampeggia per controllo la lanterna da deviatoi collegata al Decoder Digital installabile.

### fx (MM)

Prima della programmazione il deviatoio da programmare deve venire commutato con la Keyboard. Dopo di ciò le CV vengono immediatamente modificate con la Control Unit o rispettivamente la configurazione CV della Central Station. Dopodiché si commuti subito nuovamente il deviatoio programmato con la Keyboard. Soltanto ora la programmazione è acquisita ed operativa.

CV	Significato	Valori	
8	Ripristino Decoder	8 (-)	Impostazioni di fabbrica, il valore non viene scritto
37	Inversione corsa di lavoro	0-1 (0)	Modifica la direzione di commutazione

Il modo operativo nella programmazione con la Central Unit 6021 corrisponde alla programmazione della locomotive ([www.maerklin.de](http://www.maerklin.de) -> Tools & Downloads -> Technische Informationen).

## DCC

CV	Significato	Valori	
1	Indirizzo, byte di valore più basso	0-255 (1)	
7	Numero di versione del fabbricante (Versione Software)	(-)	sola lettura
8	ID identificativo del fabbricante Ripristino Decoder	(131) 8 (-)	sola lettura, Impostazioni di fabbrica, il valore non viene scritto
9	Indirizzo, byte di valore più alto	0-7 (0)	
29	Configurazione	(192)	sola lettura
	I bit 0-4 non vengono usati	0	
	Bit 5: tipo di Decoder	0 / 32	Decoder per accessori di base o esteso
	Bit 6: metodo di indirizzamento	0 / 64	Indirizzo Decoder o di uscita
	Bit 7: tipo di Decoder	128	Decoder per accessori
37	Inversione corsa di lavoro	0-1 (0)	Modifica la direzione di commutazione

### Impostazione e calcolo degli indirizzi maggiori di 255:

Ad es. indirizzo 1044 ->  $1044:256=4,078125$ . Il valore prima della virgola (4) si deve inserire in CV 9. Il valore dopo la virgola (0,078125) viene moltiplicato per 256:  $0,078125 \times 256=20$ . Il valore calcolato 20 deve venire inserito in CV 1.

**Vorbereitung und Aufbau • Preparation and Building •  
Préparation et Construction • Voorbereiding en Structuur •  
Preparativos y montaje • Preparativi e montaggio**

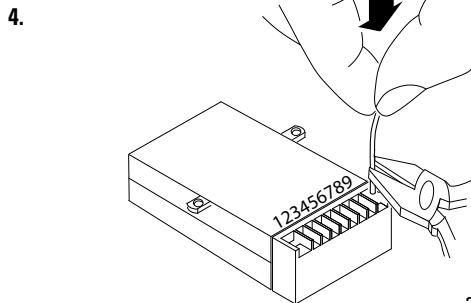
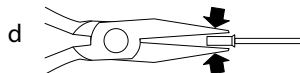
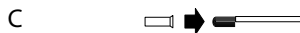
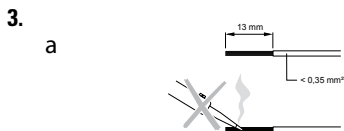
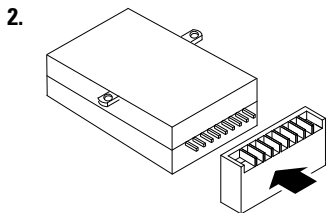
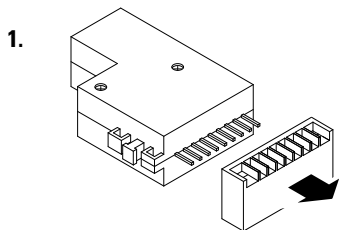

5.

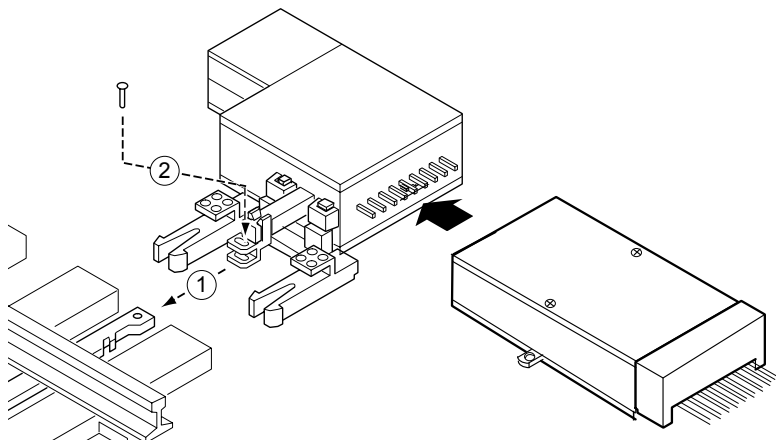



6.

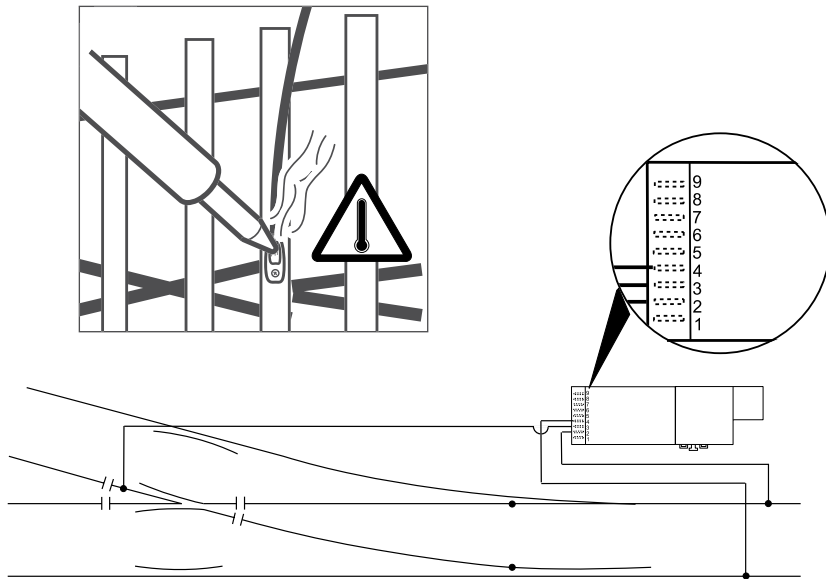

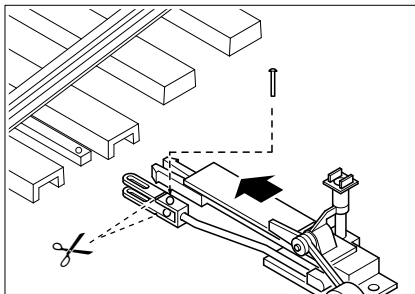
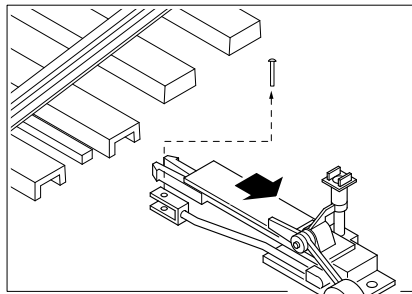
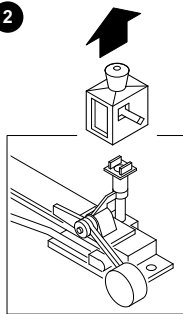
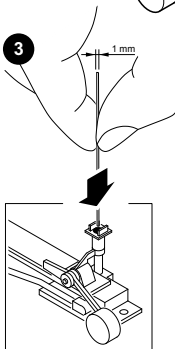
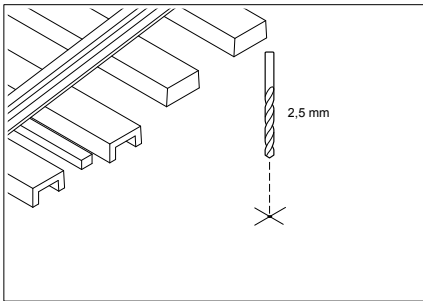
**1****4****2****3****5**

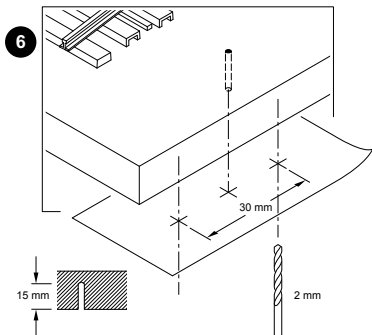

Die Bohrschablone zum Anzeichnen finden Sie auf Seite 41.

For drilling template, see page 41.

Gabarit de perçage, voir page 41.

Boorsjabloon, zie pagina 41.

En la página 41 encontrará la plantilla de taladrado para trazado.

La maschera di foratura per il tracciamento potete trovarla a pagina 41.

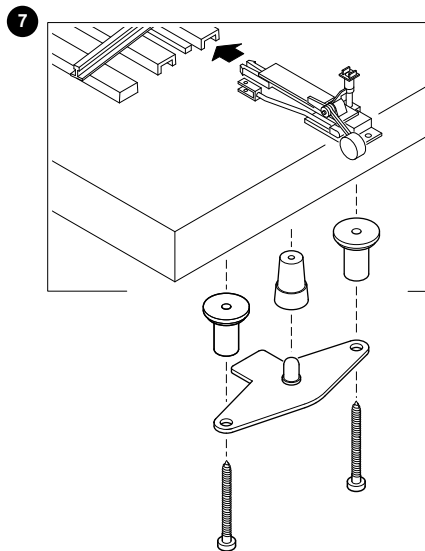

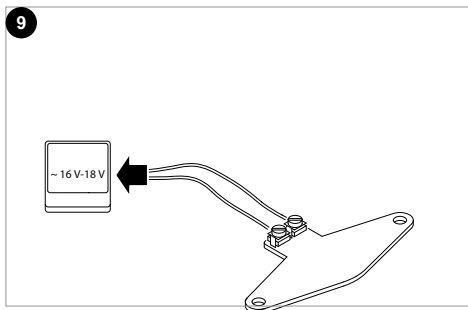
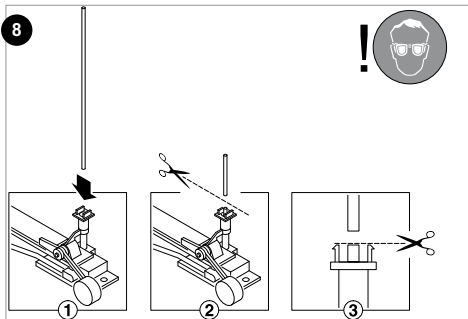



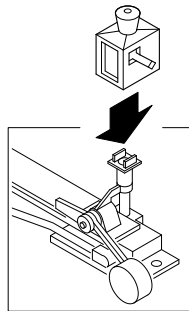

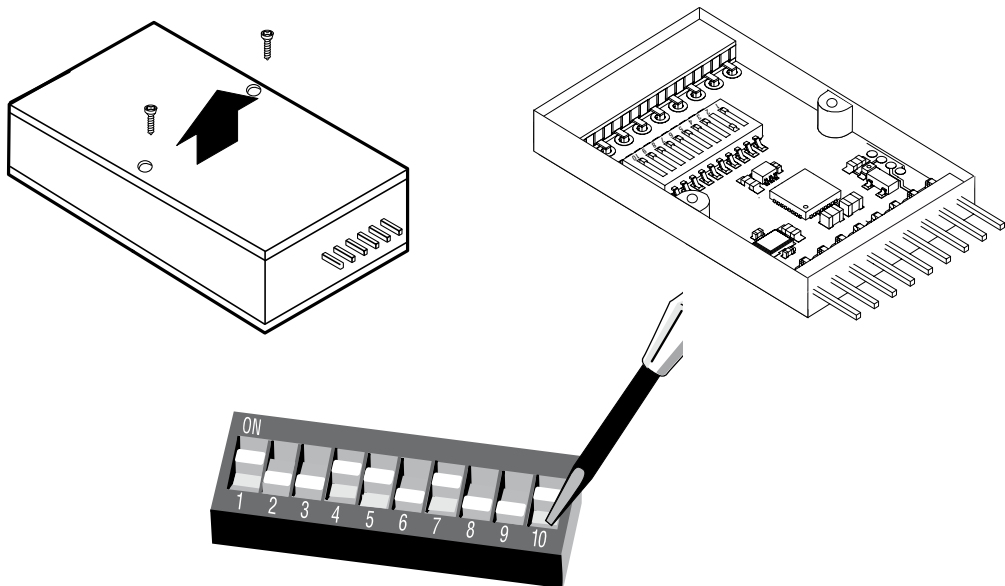

**10**









**Betriebsart und Adressen einstellen • Setting the mode of operation and addresses • Définir le mode d'exploitation et les adresses • Bedrijfsmodus en adres instellen • Configuración de modo de funcionamiento y direcciones • Impostare tipo di funzionamento e indirizzi**









				10 (0/1)				
1	1	1	1					fx (MM)/DCC
2	1	2	2					fx (MM)/DCC
3	1	3	1 2					fx (MM)/DCC
4	1	4		3				fx (MM)/DCC
5	1	5	1 3					fx (MM)/DCC
6	1	6		2 3				fx (MM)/DCC
7	1	7	1 2 3					fx (MM)/DCC
8	1	8			4			fx (MM)/DCC
9	1	9	1		4			fx (MM)/DCC
10	1	10		2	4			fx (MM)/DCC
11	1	11	1 2		4			fx (MM)/DCC
12	1	12		3 4				fx (MM)/DCC
13	1	13	1	3 4				fx (MM)/DCC
14	1	14		2 3 4				fx (MM)/DCC
15	1	15	1 2 3 4					fx (MM)/DCC
16	1	16				5		fx (MM)/DCC
17	2	1	1			5		fx (MM)/DCC
18	2	2		2		5		fx (MM)/DCC
19	2	3	1 2			5		fx (MM)/DCC
20	2	4		3	5			fx (MM)/DCC
21	2	5	1	3	5			fx (MM)/DCC
22	2	6		2 3	5			fx (MM)/DCC
23	2	7	1 2 3		5			fx (MM)/DCC
24	2	8			4 5			fx (MM)/DCC
25	2	9	1		4 5			fx (MM)/DCC
26	2	10		2	4 5			fx (MM)/DCC

				10 (0/1)				
27	2	11	1 2		4 5			fx (MM)/DCC
28	2	12		3 4 5				fx (MM)/DCC
29	2	13	1	3 4 5				fx (MM)/DCC
30	2	14		2 3 4 5				fx (MM)/DCC
31	2	15	1 2 3 4 5					fx (MM)/DCC
32	2	16				6		fx (MM)/DCC
33	3	1	1			6		fx (MM)/DCC
34	3	2		2		6		fx (MM)/DCC
35	3	3	1 2			6		fx (MM)/DCC
36	3	4		3		6		fx (MM)/DCC
37	3	5	1	3		6		fx (MM)/DCC
38	3	6		2 3		6		fx (MM)/DCC
39	3	7	1 2 3			6		fx (MM)/DCC
40	3	8			4 6			fx (MM)/DCC
41	3	9	1		4 6			fx (MM)/DCC
42	3	10		2 4	6			fx (MM)/DCC
43	3	11	1 2	4 6				fx (MM)/DCC
44	3	12		3 4 6				fx (MM)/DCC
45	3	13	1	3 4 6				fx (MM)/DCC
46	3	14		2 3 4 6				fx (MM)/DCC
47	3	15	1 2 3 4		6			fx (MM)/DCC
48	3	16			5 6			fx (MM)/DCC
49	4	1	1		5 6			fx (MM)/DCC
50	4	2		2	5 6			fx (MM)/DCC
51	4	3	1 2		5 6			fx (MM)/DCC



										
			10 ( 0/1 )							
52	4	4		3	5	6			fx (MM)/DCC	
53	4	5	1	3	5	6			fx (MM)/DCC	
54	4	6		2	3	5	6		fx (MM)/DCC	
55	4	7	1	2	3	5	6		fx (MM)/DCC	
56	4	8			4	5	6		fx (MM)/DCC	
57	4	9	1		4	5	6		fx (MM)/DCC	
58	4	10		2	4	5	6		fx (MM)/DCC	
59	4	11	1	2		4	5	6	fx (MM)/DCC	
60	4	12			3	4	5	6	fx (MM)/DCC	
61	4	13	1		3	4	5	6	fx (MM)/DCC	
62	4	14		2	3	4	5	6	fx (MM)/DCC	
63	4	15	1	2	3	4	5	6	fx (MM)/DCC	
64	4	16						7	fx (MM)/DCC	
65	5	1	1					7	fx (MM)/DCC	
66	5	2		2				7	fx (MM)/DCC	
67	5	3	1	2				7	fx (MM)/DCC	
68	5	4			3			7	fx (MM)/DCC	
69	5	5	1		3			7	fx (MM)/DCC	
70	5	6		2	3			7	fx (MM)/DCC	
71	5	7	1	2	3			7	fx (MM)/DCC	
72	5	8				4		7	fx (MM)/DCC	
73	5	9	1			4		7	fx (MM)/DCC	
74	5	10		2		4		7	fx (MM)/DCC	
75	5	11	1	2			4	7	fx (MM)/DCC	
76	5	12			3	4		7	fx (MM)/DCC	



										
			10 ( 0/1 )							
77	5	13	1		3	4		7	fx (MM)/DCC	
78	5	14		2	3	4		7	fx (MM)/DCC	
79	5	15	1	2	3	4		7	fx (MM)/DCC	
80	5	16					5	7	fx (MM)/DCC	
81	6	1	1				5	7	fx (MM)/DCC	
82	6	2		2			5	7	fx (MM)/DCC	
83	6	3	1	2			5	7	fx (MM)/DCC	
84	6	4			3		5	7	fx (MM)/DCC	
85	6	5	1		3		5	7	fx (MM)/DCC	
86	6	6		2	3		5	7	fx (MM)/DCC	
87	6	7	1	2	3		5	7	fx (MM)/DCC	
88	6	8				4	5	7	fx (MM)/DCC	
89	6	9	1			4	5	7	fx (MM)/DCC	
90	6	10		2		4	5	7	fx (MM)/DCC	
91	6	11	1	2		4	5	7	fx (MM)/DCC	
92	6	12			3	4	5	7	fx (MM)/DCC	
93	6	13	1		3	4	5	7	fx (MM)/DCC	
94	6	14		2	3	4	5	7	fx (MM)/DCC	
95	6	15	1	2	3	4	5	7	fx (MM)/DCC	
96	6	16					6	7	fx (MM)/DCC	
97	7	1	1				6	7	fx (MM)/DCC	
98	7	2		2			6	7	fx (MM)/DCC	
99	7	3	1	2			6	7	fx (MM)/DCC	
100	7	4			3		6	7	fx (MM)/DCC	
101	7	5	1		3		6	7	fx (MM)/DCC	



				10 (0/1)		
102	7	6	2 3	6 7	fx (MM)/DCC	
103	7	7	1 2 3	6 7	fx (MM)/DCC	
104	7	8	4	6 7	fx (MM)/DCC	
105	7	9	1	4 6 7	fx (MM)/DCC	
106	7	10	2	4 6 7	fx (MM)/DCC	
107	7	11	1 2	4 6 7	fx (MM)/DCC	
108	7	12	3 4	6 7	fx (MM)/DCC	
109	7	13	1	3 4 6 7	fx (MM)/DCC	
110	7	14	2 3 4	6 7	fx (MM)/DCC	
111	7	15	1 2 3 4	6 7	fx (MM)/DCC	
112	7	16		5 6 7	fx (MM)/DCC	
113	8	1	1	5 6 7	fx (MM)/DCC	
114	8	2	2	5 6 7	fx (MM)/DCC	
115	8	3	1 2	5 6 7	fx (MM)/DCC	
116	8	4	3	5 6 7	fx (MM)/DCC	
117	8	5	1	3 5 6 7	fx (MM)/DCC	
118	8	6	2 3	5 6 7	fx (MM)/DCC	
119	8	7	1 2 3	5 6 7	fx (MM)/DCC	
120	8	8	4	5 6 7	fx (MM)/DCC	
121	8	9	1	4 5 6 7	fx (MM)/DCC	
122	8	10	2	4 5 6 7	fx (MM)/DCC	
123	8	11	1 2	4 5 6 7	fx (MM)/DCC	
124	8	12	3 4	5 6 7	fx (MM)/DCC	
125	8	13	1	3 4 5 6 7	fx (MM)/DCC	
126	8	14	2 3 4	5 6 7	fx (MM)/DCC	
127	8	15	1 2 3 4	5 6 7	fx (MM)/DCC	



				10 (0/1)		
128	8	16		8	fx (MM)/DCC	
129	9	1	1	8	fx (MM)/DCC	
130	9	2	2	8	fx (MM)/DCC	
131	9	3	1 2	8	fx (MM)/DCC	
132	9	4	3	8	fx (MM)/DCC	
133	9	5	1 3	8	fx (MM)/DCC	
134	9	6	2 3	8	fx (MM)/DCC	
135	9	7	1 2 3	8	fx (MM)/DCC	
136	9	8	4	8	fx (MM)/DCC	
137	9	9	1	4 8	fx (MM)/DCC	
138	9	10	2 4	8	fx (MM)/DCC	
139	9	11	1 2 4	8	fx (MM)/DCC	
140	9	12	3 4	8	fx (MM)/DCC	
141	9	13	1	3 4 8	fx (MM)/DCC	
142	9	14	2 3 4	8	fx (MM)/DCC	
143	9	15	1 2 3 4	8	fx (MM)/DCC	
144	9	16	5	8	fx (MM)/DCC	
145	10	1	1	5 8	fx (MM)/DCC	
146	10	2	2	5 8	fx (MM)/DCC	
147	10	3	1 2	5 8	fx (MM)/DCC	
148	10	4	3	5 8	fx (MM)/DCC	
149	10	5	1	3 5 8	fx (MM)/DCC	
150	10	6	2 3	5 8	fx (MM)/DCC	
151	10	7	1 2 3	5 8	fx (MM)/DCC	
152	10	8	4 5	8	fx (MM)/DCC	
153	10	9	1	4 5 8	fx (MM)/DCC	





							10 (0/1)		
154	10	10	2	4	5	8	fx (MM)/DCC		
155	10	11	1 2	4	5	8	fx (MM)/DCC		
156	10	12	3	4	5	8	fx (MM)/DCC		
157	10	13	1	3	4	5	8	fx (MM)/DCC	
158	10	14	2	3	4	5	8	fx (MM)/DCC	
159	10	15	1 2	3	4	5	8	fx (MM)/DCC	
160	10	16			6	8	fx (MM)/DCC		
161	11	1	1			6	8	fx (MM)/DCC	
162	11	2	2			6	8	fx (MM)/DCC	
163	11	3	1 2			6	8	fx (MM)/DCC	
164	11	4	3			6	8	fx (MM)/DCC	
165	11	5	1	3		6	8	fx (MM)/DCC	
166	11	6	2	3		6	8	fx (MM)/DCC	
167	11	7	1 2	3		6	8	fx (MM)/DCC	
168	11	8		4		6	8	fx (MM)/DCC	
169	11	9	1		4	6	8	fx (MM)/DCC	
170	11	10	2	4		6	8	fx (MM)/DCC	
171	11	11	1 2	4		6	8	fx (MM)/DCC	
172	11	12	3	4		6	8	fx (MM)/DCC	
173	11	13	1	3	4	6	8	fx (MM)/DCC	
174	11	14	2	3	4	6	8	fx (MM)/DCC	
175	11	15	1 2	3	4	6	8	fx (MM)/DCC	
176	11	16			5	6	8	fx (MM)/DCC	
177	12	1	1			5	6	8	fx (MM)/DCC
178	12	2	2			5	6	8	fx (MM)/DCC
179	12	3	1 2			5	6	8	fx (MM)/DCC



							10 (0/1)		
180	12	4		3	5	6	8	fx (MM)/DCC	
181	12	5	1	3	5	6	8	fx (MM)/DCC	
182	12	6	2	3	5	6	8	fx (MM)/DCC	
183	12	7	1 2	3	5	6	8	fx (MM)/DCC	
184	12	8			4	5	6	8	fx (MM)/DCC
185	12	9	1		4	5	6	8	fx (MM)/DCC
186	12	10	2		4	5	6	8	fx (MM)/DCC
187	12	11	1 2		4	5	6	8	fx (MM)/DCC
188	12	12	3	4	5	6	8	fx (MM)/DCC	
189	12	13	1	3	4	5	6	8	fx (MM)/DCC
190	12	14	2	3	4	5	6	8	fx (MM)/DCC
191	12	15	1 2	3	4	5	6	8	fx (MM)/DCC
192	12	16				7	8	fx (MM)/DCC	
193	13	1	1			7	8	fx (MM)/DCC	
194	13	2	2			7	8	fx (MM)/DCC	
195	13	3	1 2			7	8	fx (MM)/DCC	
196	13	4	3			7	8	fx (MM)/DCC	
197	13	5	1	3		7	8	fx (MM)/DCC	
198	13	6	2	3		7	8	fx (MM)/DCC	
199	13	7	1 2	3		7	8	fx (MM)/DCC	
200	13	8			4	7	8	fx (MM)/DCC	
201	13	9	1		4	7	8	fx (MM)/DCC	
202	13	10	2		4	7	8	fx (MM)/DCC	
203	13	11	1 2		4	7	8	fx (MM)/DCC	
204	13	12		3	4	7	8	fx (MM)/DCC	
205	13	13	1	3	4	7	8	fx (MM)/DCC	



													10 (0/1)		
	keyboard	keyboard	1	2	3	4	5	6	7	8	9	0			
206	13	14		2	3	4				7	8			fx (MM)/DCC	
207	13	15	1	2	3	4				7	8			fx (MM)/DCC	
208	13	16					5			7	8			fx (MM)/DCC	
209	14	1	1				5			7	8			fx (MM)/DCC	
210	14	2		2			5			7	8			fx (MM)/DCC	
211	14	3	1	2			5			7	8			fx (MM)/DCC	
212	14	4			3		5			7	8			fx (MM)/DCC	
213	14	5	1		3		5			7	8			fx (MM)/DCC	
214	14	6		2	3		5			7	8			fx (MM)/DCC	
215	14	7	1	2	3		5			7	8			fx (MM)/DCC	
216	14	8				4	5			7	8			fx (MM)/DCC	
217	14	9	1			4	5			7	8			fx (MM)/DCC	
218	14	10		2		4	5			7	8			fx (MM)/DCC	
219	14	11	1	2		4	5			7	8			fx (MM)/DCC	
220	14	12			3	4	5			7	8			fx (MM)/DCC	
221	14	13	1		3	4	5			7	8			fx (MM)/DCC	
222	14	14		2	3	4	5			7	8			fx (MM)/DCC	
223	14	15	1	2	3	4	5			7	8			fx (MM)/DCC	
224	14	16						6	7	8				fx (MM)/DCC	
225	15	1	1					6	7	8				fx (MM)/DCC	
226	15	2		2				6	7	8				fx (MM)/DCC	
227	15	3	1	2				6	7	8				fx (MM)/DCC	
228	15	4			3			6	7	8				fx (MM)/DCC	
229	15	5	1		3			6	7	8				fx (MM)/DCC	
230	15	6		2	3			6	7	8				fx (MM)/DCC	
231	15	7	1	2	3			6	7	8				fx (MM)/DCC	



													10 (0/1)		
	keyboard	keyboard	1	2	3	4	5	6	7	8	9	0			
232	15	8					4		6	7	8			fx (MM)/DCC	
233	15	9	1				4		6	7	8			fx (MM)/DCC	
234	15	10		2			4		6	7	8			fx (MM)/DCC	
235	15	11	1	2			4		6	7	8			fx (MM)/DCC	
236	15	12			3	4		6	7	8				fx (MM)/DCC	
237	15	13	1		3	4		6	7	8				fx (MM)/DCC	
238	15	14		2	3	4		6	7	8				fx (MM)/DCC	
239	15	15	1	2	3	4		6	7	8				fx (MM)/DCC	
240	15	16					5	6	7	8				fx (MM)/DCC	
241	16	1	1				5	6	7	8				fx (MM)/DCC	
242	16	2		2			5	6	7	8				fx (MM)/DCC	
243	16	3	1	2			5	6	7	8				fx (MM)/DCC	
244	16	4			3		5	6	7	8				fx (MM)/DCC	
245	16	5	1		3		5	6	7	8				fx (MM)/DCC	
246	16	6		2	3		5	6	7	8				fx (MM)/DCC	
247	16	7	1	2	3		5	6	7	8				fx (MM)/DCC	
248	16	8				4	5	6	7	8				fx (MM)/DCC	
249	16	9	1			4	5	6	7	8				fx (MM)/DCC	
250	16	10		2		4	5	6	7	8				fx (MM)/DCC	
251	16	11	1	2		4	5	6	7	8				fx (MM)/DCC	
252	16	12			3	4	5	6	7	8				fx (MM)/DCC	
253	16	13	1		3	4	5	6	7	8				fx (MM)/DCC	
254	16	14		2	3	4	5	6	7	8				fx (MM)/DCC	
255	16	15	1	2	3	4	5	6	7	8				fx (MM)/DCC	
256	16	16										9		fx (MM)/DCC	
257	17	1	1										9	fx (MM)/DCC	









																				
			10 (0/1)																	
310	20	6	2	3	5	6	9	fx (MM)/DCC												
311	20	7	1	2	3	5	6	9	fx (MM)/DCC											
312	20	8			4	5	6	9	fx (MM)/DCC											
313	20	9	1			4	5	6	9	fx (MM)/DCC										
314	20	10	2			4	5	6	9	fx (MM)/DCC										
315	20	11	1	2		4	5	6	9	fx (MM)/DCC										
316	20	12			3	4	5	6	9	fx (MM)/DCC										
317	20	13	1		3	4	5	6	9	fx (MM)/DCC										
318	20	14		2	3	4	5	6	9	fx (MM)/DCC										
319	20	15	1	2	3	4	5	6	9	fx (MM)/DCC										
320	20	16					7	9	fx (MM)/DCC											
321	21	1	1				7	9	---/DCC											
322	21	2		2			7	9	---/DCC											
323	21	3	1	2			7	9	---/DCC											
324	21	4			3		7	9	---/DCC											
325	21	5	1		3		7	9	---/DCC											
326	21	6		2	3		7	9	---/DCC											
327	21	7	1	2	3		7	9	---/DCC											
328	21	8				4	7	9	---/DCC											
329	21	9	1			4	7	9	---/DCC											
330	21	10		2		4	7	9	---/DCC											
331	21	11	1	2		4	7	9	---/DCC											
332	21	12			3	4	7	9	---/DCC											
333	21	13	1		3	4	7	9	---/DCC											
334	21	14		2	3	4	7	9	---/DCC											
335	21	15	1	2	3	4	7	9	---/DCC											



																				
			10 (0/1)																	
336	21	16					5	7	9	---/DCC										
337	22	1	1				5	7	9	---/DCC										
338	22	2		2			5	7	9	---/DCC										
339	22	3	1	2			5	7	9	---/DCC										
340	22	4			3		5	7	9	---/DCC										
341	22	5	1		3		5	7	9	---/DCC										
342	22	6		2	3		5	7	9	---/DCC										
343	22	7	1	2	3		5	7	9	---/DCC										
344	22	8				4	5	7	9	---/DCC										
345	22	9	1			4	5	7	9	---/DCC										
346	22	10		2		4	5	7	9	---/DCC										
347	22	11	1	2		4	5	7	9	---/DCC										
348	22	12			3	4	5	7	9	---/DCC										
349	22	13	1		3	4	5	7	9	---/DCC										
350	22	14		2	3	4	5	7	9	---/DCC										
351	22	15	1	2	3	4	5	7	9	---/DCC										
352	22	16					6	7	9	---/DCC										
353	23	1	1				6	7	9	---/DCC										
354	23	2		2			6	7	9	---/DCC										
355	23	3	1	2			6	7	9	---/DCC										
356	23	4			3		6	7	9	---/DCC										
357	23	5	1		3		6	7	9	---/DCC										
358	23	6		2	3		6	7	9	---/DCC										
359	23	7	1	2	3		6	7	9	---/DCC										
360	23	8				4	6	7	9	---/DCC										
361	23	9	1			4	6	7	9	---/DCC										



													10 (0/1)
362	23	10		2		4		6	7	9	---	/DCC	
363	23	11	1	2		4		6	7	9	---	/DCC	
364	23	12			3	4		6	7	9	---	/DCC	
365	23	13	1		3	4		6	7	9	---	/DCC	
366	23	14		2	3	4		6	7	9	---	/DCC	
367	23	15	1	2	3	4		6	7	9	---	/DCC	
368	23	16					5	6	7	9	---	/DCC	
369	24	1	1				5	6	7	9	---	/DCC	
370	24	2		2			5	6	7	9	---	/DCC	
371	24	3	1	2			5	6	7	9	---	/DCC	
372	24	4			3		5	6	7	9	---	/DCC	
373	24	5	1		3		5	6	7	9	---	/DCC	
374	24	6		2	3		5	6	7	9	---	/DCC	
375	24	7	1	2	3		5	6	7	9	---	/DCC	
376	24	8				4	5	6	7	9	---	/DCC	
377	24	9	1			4	5	6	7	9	---	/DCC	
378	24	10		2		4	5	6	7	9	---	/DCC	
379	24	11	1	2		4	5	6	7	9	---	/DCC	
380	24	12			3	4	5	6	7	9	---	/DCC	
381	24	13	1		3	4	5	6	7	9	---	/DCC	
382	24	14		2	3	4	5	6	7	9	---	/DCC	
383	24	15	1	2	3	4	5	6	7	9	---	/DCC	
384	24	16								8	9	---	/DCC
385	25	1	1							8	9	---	/DCC
386	25	2		2						8	9	---	/DCC
387	25	3	1	2						8	9	---	/DCC

													10 (0/1)
388	25	4				3				8	9	---	/DCC
389	25	5	1		3					8	9	---	/DCC
390	25	6		2	3					8	9	---	/DCC
391	25	7	1	2	3					8	9	---	/DCC
392	25	8					4			8	9	---	/DCC
393	25	9	1			4				8	9	---	/DCC
394	25	10		2		4				8	9	---	/DCC
395	25	11	1	2		4				8	9	---	/DCC
396	25	12			3	4				8	9	---	/DCC
397	25	13	1		3	4				8	9	---	/DCC
398	25	14		2	3	4				8	9	---	/DCC
399	25	15	1	2	3	4				8	9	---	/DCC
400	25	16						5		8	9	---	/DCC
401	26	1	1				5			8	9	---	/DCC
402	26	2		2			5			8	9	---	/DCC
403	26	3	1	2			5			8	9	---	/DCC
404	26	4			3		5			8	9	---	/DCC
405	26	5	1		3		5			8	9	---	/DCC
406	26	6		2	3		5			8	9	---	/DCC
407	26	7	1	2	3		5			8	9	---	/DCC
408	26	8				4	5			8	9	---	/DCC
409	26	9	1			4	5			8	9	---	/DCC
410	26	10		2		4	5			8	9	---	/DCC
411	26	11	1	2		4	5			8	9	---	/DCC
412	26	12			3	4	5			8	9	---	/DCC
413	26	13	1		3	4	5			8	9	---	/DCC

													10 (0/1)
			1	2	3	4	5	6	7	8	9	0	
414		26 14		2	3	4	5		8	9			---/DCC
415		26 15	1	2	3	4	5		8	9			---/DCC
416		26 16						6	8	9			---/DCC
417		27 1	1					6	8	9			---/DCC
418		27 2		2				6	8	9			---/DCC
419		27 3	1	2				6	8	9			---/DCC
420		27 4			3			6	8	9			---/DCC
421		27 5	1		3			6	8	9			---/DCC
422		27 6		2	3			6	8	9			---/DCC
423		27 7	1	2	3			6	8	9			---/DCC
424		27 8				4		6	8	9			---/DCC
425		27 9	1			4		6	8	9			---/DCC
426		27 10		2		4		6	8	9			---/DCC
427		27 11	1	2		4		6	8	9			---/DCC
428		27 12			3	4		6	8	9			---/DCC
429		27 13	1		3	4		6	8	9			---/DCC
430		27 14		2	3	4		6	8	9			---/DCC
431		27 15	1	2	3	4		6	8	9			---/DCC
432		27 16					5	6	8	9			---/DCC
433		28 1	1				5	6	8	9			---/DCC
434		28 2		2			5	6	8	9			---/DCC
435		28 3	1	2			5	6	8	9			---/DCC
436		28 4			3		5	6	8	9			---/DCC
437		28 5	1		3		5	6	8	9			---/DCC
438		28 6		2	3		5	6	8	9			---/DCC
439		28 7	1	2	3		5	6	8	9			---/DCC

													10 (0/1)
			1	2	3	4	5	6	7	8	9	0	
440		28 8					4	5	6	8	9		---/DCC
441		28 9	1				4	5	6	8	9		---/DCC
442		28 10		2			4	5	6	8	9		---/DCC
443		28 11	1	2			4	5	6	8	9		---/DCC
444		28 12			3		4	5	6	8	9		---/DCC
445		28 13	1		3		4	5	6	8	9		---/DCC
446		28 14		2	3		4	5	6	8	9		---/DCC
447		28 15	1	2	3		4	5	6	8	9		---/DCC
448		28 16								7	8	9	---/DCC
449		29 1	1							7	8	9	---/DCC
450		29 2		2						7	8	9	---/DCC
451		29 3	1	2						7	8	9	---/DCC
452		29 4			3					7	8	9	---/DCC
453		29 5	1		3					7	8	9	---/DCC
454		29 6		2	3					7	8	9	---/DCC
455		29 7	1	2	3					7	8	9	---/DCC
456		29 8				4				7	8	9	---/DCC
457		29 9	1			4				7	8	9	---/DCC
458		29 10		2		4				7	8	9	---/DCC
459		29 11	1	2		4				7	8	9	---/DCC
460		29 12			3	4				7	8	9	---/DCC
461		29 13	1		3	4				7	8	9	---/DCC
462		29 14		2	3	4				7	8	9	---/DCC
463		29 15	1	2	3	4				7	8	9	---/DCC
464		29 16					5			7	8	9	---/DCC
465		30 1	1				5			7	8	9	---/DCC

																
			10 ( 0/1 )													
466	30	2	2		5	7	8	9	---/DCC							
467	30	3	1	2		5	7	8	9	---/DCC						
468	30	4		3		5	7	8	9	---/DCC						
469	30	5	1		3		5	7	8	9	---/DCC					
470	30	6		2	3		5	7	8	9	---/DCC					
471	30	7	1	2	3		5	7	8	9	---/DCC					
472	30	8			4	5		7	8	9	---/DCC					
473	30	9	1			4	5		7	8	9	---/DCC				
474	30	10		2		4	5		7	8	9	---/DCC				
475	30	11	1	2		4	5		7	8	9	---/DCC				
476	30	12			3	4	5		7	8	9	---/DCC				
477	30	13	1		3	4	5		7	8	9	---/DCC				
478	30	14		2	3	4	5		7	8	9	---/DCC				
479	30	15	1	2	3	4	5		7	8	9	---/DCC				
480	30	16					6	7	8	9	---/DCC					
481	31	1	1				6	7	8	9	---/DCC					
482	31	2		2			6	7	8	9	---/DCC					
483	31	3	1	2			6	7	8	9	---/DCC					
484	31	4			3		6	7	8	9	---/DCC					
485	31	5	1		3		6	7	8	9	---/DCC					
486	31	6		2	3		6	7	8	9	---/DCC					
487	31	7	1	2	3		6	7	8	9	---/DCC					
488	31	8				4	6	7	8	9	---/DCC					
489	31	9	1			4	6	7	8	9	---/DCC					
490	31	10		2		4	6	7	8	9	---/DCC					
491	31	11	1	2		4	6	7	8	9	---/DCC					

																	
			10 ( 0/1 )														
492	31	12				3	4		6	7	8	9	---/DCC				
493	31	13	1			3	4		6	7	8	9	---/DCC				
494	31	14		2	3	4		6	7	8	9	---/DCC					
495	31	15	1	2	3	4		6	7	8	9	---/DCC					
496	31	16					5	6	7	8	9	---/DCC					
497	32	1	1				5	6	7	8	9	---/DCC					
498	32	2		2			5	6	7	8	9	---/DCC					
499	32	3	1	2			5	6	7	8	9	---/DCC					
500	32	4			3		5	6	7	8	9	---/DCC					
501	32	5	1		3		5	6	7	8	9	---/DCC					
502	32	6		2	3		5	6	7	8	9	---/DCC					
503	32	7	1	2	3		5	6	7	8	9	---/DCC					
504	32	8				4	5	6	7	8	9	---/DCC					
505	32	9	1			4	5	6	7	8	9	---/DCC					
506	32	10		2		4	5	6	7	8	9	---/DCC					
507	32	11	1	2		4	5	6	7	8	9	---/DCC					
508	32	12			3	4	5	6	7	8	9	---/DCC					
509	32	13	1		3	4	5	6	7	8	9	---/DCC					
510	32	14		2	3	4	5	6	7	8	9	---/DCC					
511	32	15	1	2	3	4	5	6	7	8	9	---/DCC					

Adressen größer 511 können nur im DCC Format ausgegeben werden und müssen mit der CV Programmierung über das Programmiergleis durchgeführt werden.

Addresses larger than 511 can only be assigned in the DCC format and must be done by programming a CV using the programming track.

Les adresses supérieures à 511 peuvent uniquement être éditées dans le format DCC et doivent être exécutées avec la programmation des CV via la voie de programmation.

Adressen groter dan 511 kunnen alleen in het DCC formaat gebruikt worden en moeten met de CV programmering via het programmeerspoor ingesteld worden.

Las direcciones superiores a 511 pueden mostrarse en el formato DCC y deben configurarse con la función Programación de CVs mediante la vía de programación.

Indirizzi maggiori di 511 possono essere assegnati solo nel formato DCC e si devono eseguire con la programmazione delle CV tramite il binario di programmazione.



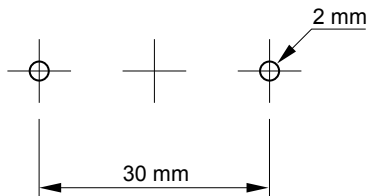





Due to different legal requirements regarding electro-magnetic compatibility, this item may be used in the USA only after separate certification for FCC compliance and an adjustment if necessary.

Use in the USA without this certification is not permitted and absolves us of any liability. If you should want such certification to be done, please contact us – also due to the additional costs incurred for this.

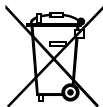

Gebr. Märklin & Cie. GmbH  
Stuttgarter Straße 55 - 57  
73033 Göppingen  
Germany  
[www.maerklin.com](http://www.maerklin.com)

[www.maerklin.com/en/imprint.html](http://www.maerklin.com/en/imprint.html)

197435/0716/Sc2Ef  
Änderungen vorbehalten  
© by Gebr. Märklin & Cie. GmbH