

märklin
H0



Hauptsignal
70391/70392/70411/70412

Inhaltsverzeichnis	Seite
Bestimmungsgemäße Verwendung	4
Lieferumfang	4
Sicherheitshinweise	4
Wichtige Hinweise	4
Technische Daten	4
Funktionen	4
Signal-Einbau	4
Programmierung mit CS 2	5
Entsorgung	6
Garantie	6
Betriebsart und Adressen einstellen	30
Aufbau	41
Aufkleber anbringen	50
Bohrschablone	51

Table of Contents	Page
Intended Use of the Product	7
Contents as Delivered	7
Safety Notes	7
Important Notes	7
Technical Data	7
Functions	7
Signal Installation	7
Programming with the CS 2	8
Disposing	9
Warranty	9
Setting the mode of operation and addresses	30
Setup	41
Attach decals	50
Drilling Template	51

Sommaire	Page
Utilisation conforme	10
Livraison	10
Consignes de sécurité	10
Consignes importantes	10
Caractéristiques techniques	10
Fonctions	10
Montage du signal	11
Programmation avec CS 2	11
Elimination	12
Garantie	12
Définir le mode d'exploitation et les adresses	30
Montage	41
Fixez les autocollants	50
Gabarit de perçage	51

Inhoudsopgave	Pagina
Beoogd gebruik	13
Leveringsomvang	13
Veiligheidsvoorschriften	13
Belangrijke aanwijzingen	13
Technische gegevens	13
Functies	13
Sein inbouwen	13
Programmeren met CS2	14
Afdanken	15
Garantie	15
Bedrijfsmodus en adres instellen	30
Opbouwen	41
Bevestig stickers	50
Boorsjabloon	51

Índice	Página	Innehållsförteckning	Sidan
Uso previsto	16	Användningsområde	24
Alcance de suministro	16	Innehåll	24
Instrucciones de seguridad	16	Säkerhetsföreskrifter	24
Consejos importantes	16	Viktig information	24
Datos técnicos	16	Tekniska data	24
Funciones	16	Funktioner	24
Montaje de la señal	16	Signal-inbyggnad	25
Programación con CS 2	17	Programmering med CS 2	25
Eliminación	18	Källsortering	26
Garantía	19	Garanti	26
Configuración de modo de funcionamiento y direcciones	30	Ställ in driftstyp och adress	30
Montaje	41	Montering	41
Allega decalcomanie	50	Bifoga dekaler	50
Plantilla	51	Borrschablon	51
Elenco del contenido	Página	Indholdsfortegnelse	Side
Impiego commisurato alla destinazione	20	Hensigtsmæssig anvendelse	27
Corredo di forniture	20	Leveringsomfang	27
Avvertenze di sicurezza	20	Sikkerhedsvejledning	27
Avvertenze importanti	20	Vigtig information	27
Dati tecnici	20	Tekniske data	27
Funzioni	20	Funktioner	27
Montaggio del segnale	21	Signalindbygning	27
Programmazione con CS 2	21	Programmering med CS 2	28
Smaltimento	22	Bortskaffelse	29
Garanzia	23	Garanti	29
Impostate tipo di funzionamento e indirizzi	30	Indstil driftsart og adresser	30
Montaggio	41	Forsamling	41
Coloque las calcomanías	50	Vedhæft decals	50
Maschera di Foratura	51	Boreskabelon	51

Bestimmungsgemäße Verwendung

- Das Signal ist zum Einbau in H0 Digital-Modellbahn-Anlagen.
- Das Signal darf für den Analogbetrieb nur mit Stellpult 72760 verwendet werden.
- Darf nur in geschlossenen Räumen verwendet werden.

Lieferumfang

- 1 Signal
- 1 Kabel mit Stecker 2 polig, rot und braun
- 1 Kabel mit Stecker 3 polig, - rot und rot
- 1 Kabel mit Stecker 3 polig, violett, rot-braun, rot-grün,
- 2 Haltewinkel zur Unterflurmontage
- 1 Halteplatte C-Gleis
- 4 Isolierungen (rot) C-Gleis (1Spritzling)
- 2 Mittelleiter-Isolierung (grau) K-Gleis
- 1 Mittelleiter-Anschluss K-Gleis
- 1 Schiebebilder zur Kennzeichnung
- Einbauanleitung mit Schablone zur Unterflurmontage
- Garantieurkunde

Für die Unterflurmontage zusätzlich benötigtes Werkzeug: Schraubendreher, 4x Senkkopfschrauben Ø 2,5mm x (Länge abhängig von der Einbautiefe), Bohrer Ø 16mm und 2mm.

Sicherheitshinweise

- **ACHTUNG!** Funktionsbedingte scharfe Kanten und Spitzen.
- Verkabelungs- und Montagearbeiten nur im spannungslosen Zustand ausführen. Bei Nichtbeachtung kann es zu gefährlichen Körperströmen und damit zu Verletzungen führen.
- **Signal nur mit der zulässigen Spannung** (siehe technische Daten) **betreiben**.

Wichtige Hinweise

- Die Bedienungsanleitung ist Bestandteil des Produktes und muss deshalb aufbewahrt sowie bei Weitergabe des Produktes mitgegeben werden.
- Für Reparaturen wenden Sie sich bitte an Ihren Märklin-Fachhändler.
- Entsorgung: www.maerklin.com/en/imprint.html

Technische Daten

- Belastung ≤ 100 mA
- Belastung Gleis Ausgang max. 2 A
- Spannungsfestigkeit max. 40 V

Funktionen

- Multiprotokoll fähig: fx (MM), mfx* und DCC
- Einstellen der Betriebsart mittels DIP-Schalter
- Einstellbare Adressen mit DIP-Schalter:
 - 1-256** fx (MM) (Control Unit 6021)
 - 1-320** fx (MM) (Central Station 6021x/Mobile Station 60653)
 - 1-511** (DCC)
- Programmierbare Adressen über CV
 - 1-2.040** DCC
- Änderungen der Eigenschaften über CV
- Stromversorgung über Digitalstromkreis

Signal-Einbau

Vor dem eigentlichen Einbau muss das Signal programmiert werden.

Folgende Arbeitsschritte dürfen nur im spannungslosen Zustand ausgeführt werden:

Einstellung der Adresse und Betriebsart durch den DIP-Schalter:

- Einstellen der Betriebsart mit DIP-Schalter 10
Schalter 10 off = fx (MM) / mfx
Schalter 10 on = DCC
- fx (MM)/DCC einstellen der Adresse mit DIP-Schalter (Tabelle ab Seite 30)

Beachten Sie: Einstellungen mit dem DIP-Schalter immer spannungslos vornehmen. Das Signal erkennt erst mit dem Einschalten der Spannung die aktuellen Schalterstellungen.

Programmierung mit CS 2

fx (MM)

Die CV Programmierung muss am Programmiergleis erfolgen. Es darf **immer nur ein Signal** am Programmiergleis angeschlossen werden.

Folgende CV können bei fx (MM) verändert werden: CV 39, 40, 41 und 42. Bei den CV 41 und 42 muss bei fx (MM) der Wert durch 4 geteilt werden, denn es sind Werte 0-80 zulässig z.B. $255/4 = 64$ (gerundet).

Während des Programmiervorganges blinkt die Signallampe, abweichend davon wird während des programmierens mit der Central Station das Signal geschaltet. Nach Abschluss des Programmiervorganges wird das Signal auf „Fahrt“ gestellt.

Die Vorgehensweise beim Programmieren mit der Control Unit 6021 finden Sie auf www.maerklin.de -> Tools & Downloads -> Technische Informationen.

Die Programmierung mit anderen Geräten, entnehmen Sie bitte der Bedienungsanleitung des jeweiligen Steuergerätes.

DCC

Die CV Programmierung muss am Programmiergleis erfolgen. Es darf **immer nur ein Signal** am Programmiergleis angeschlossen werden.

Während der Datenübertragung blinkt zur Kontrolle die Laterne am Signal.

Die Programmierung mit anderen Geräten, entnehmen Sie bitte der Bedienungsanleitung des jeweiligen Steuergerätes.

Programmierung mit MS 2

Zur Programmierung der Signale mit der Mobile Station 2 muss eine neue Lokomotive manuell unter MM2 oder DCC angelegt werden.

Beachten Sie bitte, dass dann das zu programmierende Signal über die Codierschalter auch auf MM2 oder DCC und auf die selbe Adresse wie die Lokomotive eingestellt wurde. Diese neu angelegte Lokomotive wird nur für die Programmierung der Signale benötigt. Gehen Sie dazu im Menü der MS 2 auf „Lok konfigurieren“ und anschließend auf „CV programmieren“. Während des CV-programmierens dürfen keine anderen Lokomotiven, Signale oder Weichendecoder angeschlossen sein.

CV für fx (MM) und DCC

Unter fx (MM) kann die Adresse nur mit dem DIP-Schalter eingestellt werden. Werte in Klammern sind die Werkseinstellungen.

CV	Bedeutung	Werte	
1	Adresse 1 - 255	1-255 (1)	nur DCC
9	Adressen 256 - 2040	0-7 (0)	nur DCC

CV	Bedeutung	Werte	
39	Langsame Bewegung	0 (0)	
PoM*	Mittelschnelle Bewegung	1	
	Schnelle Bewegung	2	
	Mittelschnelle Bewegung mit Nachwippen	3	
	Schnelle Bewegung mit Nachwippen	4	
	Mittelschnelle Bewegung mit Nachwippen Flügel 1	5	nur bei 70411 / 70412
	Mittelschnelle Bewegung mit Nachwippen Flügel 2	6	nur bei 70411 / 70412
40	Beleuchtung	0 - 15 (15)	0 licht aus dimmen 0-15, wobei 15 = 100% Helligkeit entspricht
PoM*			
41	Mittelstellung Flügel 1	0 - 255	Einstellung der Mittelposition für den Flügel aller Signale
PoM*			
42	Mittelstellung Flügel 2	0 - 255	nur bei 70411 / 70412 Einstellung der Mittelposition für den 2. Flügel
PoM*			

*PoM programmieren kann, sofern es vom Steuergerät unterstützt wird, am Hauptgleis erfolgen.

Einstellen und errechnen der Adressen größer 255 (DCC):

Z.B. Adresse 1044 -> $1044:256=4,078125$. Der Wert vor dem Komma (4) ist in CV 9 einzutragen. Der Wert nach dem Komma (0,078125) wird mit 256 multipliziert $0,078125 \times 256 = 20$. Der errech-

nete Wert 20 muss in CV 1 eingetragen werden.

Entsorgung



Hinweise zum Umweltschutz: Produkte, die mit dem durchgestrichenen Mülleimer gekennzeichnet sind, dürfen am Ende ihrer Lebensdauer nicht über den normalen Haushaltsmüll entsorgt werden, sondern müssen an einem Sammelpunkt für das Recycling von elektrischen und elektronischen Geräten abgegeben werden. Das Symbol auf dem

Produkt, der Bedienungsanleitung oder der Verpackung weist darauf hin. Die Werkstoffe sind gemäß ihrer Kennzeichnung wiederverwertbar. Mit der Wiederverwendung, der stofflichen Verwertung oder anderen Formen der Verwertung von Altgeräten leisten Sie einen wichtigen Beitrag zum Schutz unserer Umwelt. Bitte erfragen Sie bei Ihrer Gemeindeverwaltung die zuständige Entsorgungsstelle.

Garantie

Gewährleistung und Garantie gemäß der beiliegenden Garantie-urkunde.

- Für Reparaturen wenden Sie sich bitte an Ihren Märklin-Fachhändler oder an
Gebr. Märklin & Cie. GmbH
Reparaturservice
Stuttgarter Str. 55 - 57
73033 Göppingen
Germany
☎: 07161 608 222 (nur aus dem Inland)
E-Mail: Service@maerklin.de

Intended Use of the Product

- This signal is for installation on H0 digital model railroad layouts.
- This signal may only be used for analog operation with the 72760 control box.
- Use only in enclosed areas.

Contents as Delivered

- 1 Signal
- 1 Cable with plug, 2-conductor, red and brown
- 1 Cable with plug, 3-conductor, red and red
- 1 Cable with plug, 3-conductor, violet, red-brown, red-green
- 2 Mounting brackets for below-baseboard installation
- 1 Mounting for C Track
- 4 Insulator sleeves (red) for C track (1 sprue)
- 2 Center conductor insulators (gray) for K Track
- 1 Center conductor connector for K Track
- 1 Set of decals for identification
- Installation instructions with a template for below-baseboard installation
- Warranty card

Additional tools required for below-baseboard installation: screwdriver, 4 each countersunk screws \varnothing 2.5 mm x (length dependent on the installation depth), drills \varnothing 16 mm and 2 mm.

Safety Notes

- **IMPORTANT!** The product has sharp edges and points due to the way it works.
- Do wiring and installation work only when there is no voltage present. Failure to adhere to this may cause life-threatening current and injury.

- **This signal is to be operated only with the permissible voltage** (see technical data).

Important Notes

- The operating instructions are a component part of the product and must therefore be kept in a safe place as well as for transfer of the product to third parties.
- Please see your authorized Märklin specialty dealer for repairs.
- Disposing of the product: www.maerklin.com/en/imprint.html

Technical Data

- Load \leq 100 milliamps
- Load at the track output max. 2 amps
- Electrical strength max. 40 volts

Functions

- Capable of multi-protocols: fx (MM), mfx*, and DCC
- Mode of operation set by means of DIP switches
- Addresses can be set by means of DIP switches:
 - 1-256** fx (MM) (Control Unit 6021)
 - 1-320** fx (MM) (Central Station 6021x/Mobile Station 60653)
 - 1-511** (DCC)
- Programmable addresses by means of CVs +**1-2,040** DCC
- Characteristics can be changed by means of CVs
- Power supplied by means of the digital current circuit

Signal Installation

The signal must be programmed before actually installing it.

The following work steps may be done only when there is no voltage present:

* mfx not until CS2 Software Version 4.0 (2nd quarter of 2015)

Setting the address and the mode of operation with the DIP switches:

- Setting the mode of operation with DIP Switch 10
Switch 10 off = fx (MM) / mfx
Switch 10 on = DCC
- fx (MM)/DCC Setting the address with DIP switches (See table starting on Page 30)

Please note: Always do settings with the DIP switches when there is no voltage present. The signal does not recognize the current switch settings until the voltage is turned on.

Programming with the CS 2

fx (MM)

The CV programming must be done on the programming track. **Only one signal** may be connected to the programming track **at a time**.

The following CVs can be changed in fx (MM): CV 39, 40, 41, and 42. With CVs 41 and 42 the value must be divided by 4 in fx (MM), because only the values 0-80 are allowed, for example:
 $255/4 = 64$ (rounded).

During the programming procedure, the signal light will blink. During programming with the Central Station, by contrast the signal is switched. After the end of the programming procedure, the signal is set at "Go".

The procedure for programming with the 6021 Control Unit can be found at www.maerklin.de -> Tools & Downloads -> Technische Informationen.

Please see the operating instructions for the control devices in question for programming with other devices.

DCC

CV programming must be done on the programming track. **Only one signal** may be connected to the programming track **at a time**.

The light on the signal will blink as a check during the data transmission.

Please see the operating instructions for the control devices in question for programming with other devices.

Programming with the MS 2

A new locomotive must be set up manually under MM2 or DCC in order to program signals with the Mobile Station 2.

Please note that the signal to be programmed is then also set by means of the coding switches to MM2 or DCC and to the same address as the locomotive. This newly set up locomotive is only required for the programming of signals. To do this go in the MS 2 menu to „Configure Locomotive“ and then to „Program CV“. No other locomotive, signals, or turnout decoders may be connected while the CV(s) are being programmed.

CV for fx (MM) and DCC

With fx (MM) the address can be set only with the DIP switches. The values in parentheses are factory default settings.

CV	Meaning	Values	
1	Address 1 - 255	1-255 (1)	only DCC
9	Addresses 256 - 2040	0-7 (0)	only DCC

CV	Meaning	Values	
39	Slow movement	0 (0)	
PoM*	Medium fast movement	1	
	Fast movement	2	
	Medium fast movement with bouncing	3	
	Fast movement with bouncing	4	
	Medium fast movement with bouncing of Arm 1	5	only with 70411 / 70412
	Medium fast movement with bouncing of Arm 2	6	only with 70411 / 70412
	40	Meaning Lighting	0 - 15 (15)
41	Center setting for Arm 1	0 - 255	Setting of the middle position for the arm on all signals
42	Center setting for Arm 2	0 - 255	Only with 70411 / 70412 Setting of the middle position for the 2nd arm

*PoM programming can be done on the main track as long as it is supported by the control device.

Setting and Calculating Addresses Greater than 255 (DCC):

Example: Address 1044 -> $1044 : 256 = 4.078125$. The value before the decimal point (4) is entered in CV 9. The value after the decimal point (0.078125) is multiplied by 256 $0.078125 \times 256 = 20$.

The calculated value of 20 must be entered in CV 1.

Disposing

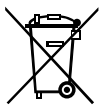

Products marked with a trash container with a line through it may not be disposed of at the end of their useful life in the normal household trash. They must be taken to a collection point for the recycling of electrical and electronic devices.

There is a symbol on the product, the operating instructions, or the packaging to this effect. The materials in these items can be used again according to this marking. By reusing old devices, materially recycling, or recycling in some other form of old devices such as these you make an important contribution to the protection of our environment. Please ask your city, town, community, or county authorities for the location of the appropriate disposal site.

Warranty

The warranty card included with this product specifies the warranty conditions.

- Please contact your authorized Märklin dealer for repairs or contact:

Gebr. Märklin & Cie. GmbH

Reparaturservice

Stuttgarter Str. 55 - 57

73033 Göppingen

Germany

☎: +49 7161 608 222

E-Mail: Service@maerklin.de

Utilisation conforme

- Le signal est conçu pour être monté sur des circuits ferroviaires miniatures numériques H0.
- Le signal ne doit être utilisé en mode analogue qu'avec un pupitre de commande 72760.
- Ne doit être utilisé que dans une pièce fermée.

Livraison

- 1 signal
- 1 câble avec prise bipolaire, rouge et marron
- 1 câble avec prise tripolaire, rouge et rouge
- 1 câble avec prise tripolaire, violet,rouge-brun, rouge-vert
- 2 équerres de fixation pour montage souterrain
- 1 plaque de maintien voie C
- 4 isolations (rouge) voie C (1 pièce moulée par injection)
- 2 isolations pour conducteur central (gris) voie K
- 1 connecteur pour conducteur central voie K
- 1 image à coulisser pour la signalisation
- Instructions de montage avec schéma pour montage souterrain
- Certificat de garantie

Outils supplémentaires requis pour le montage souterrain :
Tournevis, 4x vis à tête fraisée Ø 2,5mm x (la longueur dépendant de la profondeur de montage), perceuse Ø 16mm et 2mm.

Consignes de sécurité

- **ATTENTION !** Le matériel comporte des bords coupants et des pointes.
- Effectuer les travaux de câblage et de montage uniquement lorsque le circuit est hors tension. Dans le cas contraire, vous risquez de vous électrocuter et de vous blesser.

- **Utiliser le signal uniquement avec la tension autorisée** (cf. caractéristiques techniques).

Consignes importantes

- Le mode d'emploi fait partie intégrante du produit. Vous devez donc la conserver et la transmettre avec le produit.
- Pour les travaux de réparation, veuillez vous adresser à votre revendeur Märklin.
- Élimination : www.maerklin.com/en/imprint.html

Caractéristiques techniques

- Charge ≤ 100 mA
- Charge sortie voie max. 2 A
- Rigidité diélectrique max. 40 V

Fonctions

- Multiprotocole : fx (MM), mfx* et DCC
- Réglage du mode de fonctionnement au moyen d'un interrupteur DIP
- Adresses réglables au moyen de l'interrupteur DIP :
1-256 fx (MM) (Control Unit 6021)
1-320 fx (MM) (Central Station 6021x/Mobile Station 60653)
1-511 (DCC)
- Adresses programmables via CV
1-2 040 DCC
- Modification des propriétés via CV
- Alimentation électrique via circuit électrique numérique

Montage du signal

Avant le montage à proprement parler, vous devez programmer le signal.

* mfx à partir de la version logicielle CS2 4.0 (2e trimestre 2015)

Vous réaliserez les étapes suivantes uniquement lorsque le circuit est hors tension :

Réglage de l'adresse et du mode de fonctionnement via l'interrupteur DIP :

- Réglage du mode de fonctionnement au moyen d'un interrupteur DIP 10
Interrupteur 10 off = fx (MM) / mfx
Interrupteur 10 on = DCC
- fx (MM)/DCC Réglage de l'adresse via l'interrupteur DIP (tableau à partir de la page 30)

Attention : Effectuer les réglages via l'interrupteur DIP uniquement hors tension. Le signal reconnaît les positions du commutateur dès l'activation de la tension.

Programmation avec CS 2

fx (MM)

La programmation CV doit se faire au niveau de la voie de programmation. Vous ne devez brancher **qu'un seul signal** sur la voie de programmation.

Vous pouvez modifier les CV suivant dans fx (MM) : CV 39, 40, 41 et 42. Pour les CV 41 et 42 vous devez diviser la valeur de fx (MM) par 4 car seules des valeurs de 0-80 sont autorisées, par ex. $255/4 = 64$ (arrondie).

Pendant la programmation, la lampe du signal clignote, et, indépendamment de cela, le signal est couplé à la Central Station pendant la programmation. Une fois la procédure de programmation terminée, le signal est mis sur « circulation ».

Vous trouverez la procédure de programmation au moyen de la Control Unit 6021 à la page www.maerklin.de -> Tools & Downloads -> Technische Informationen (www.marklin.fr/fr/produits/

[outils/base_donnees_produits.html](#))

Pour la programmation avec d'autres appareils, veuillez consulter les modes d'emploi des pupitres de commande correspondant.

DCC

La programmation CV doit se faire au niveau de la voie de programmation. ne devez brancher **qu'un seul signal** sur la voie de programmation.

Pendant la transmission des données, la lanterne du signal clignote.

Pour la programmation avec d'autres appareils, veuillez consulter les modes d'emploi des pupitres de commande correspondant.

Programmation avec MS 2

La programmation des signaux avec la Mobile Station 2 nécessite la création manuelle d'une nouvelle locomotive sous MM2 ou DCC. Veuillez tenir compte du fait que le signal à programmer aura alors été paramétré via les commutateurs de codage également sur MM2 ou DCC et sur la même adresse que la locomotive. Cette nouvelle locomotive créée est requise uniquement pour la programmation des signaux. A cet effet, allez dans le menu de la MS 2 sur « Configuration loco », puis sur « Programmation CV ». Pendant la programmation des CV, aucune autre locomotive ni aucun autre signal ou décodeur d'aiguille ne doit être raccordé.

CV pour fx (MM) et DCC

Dans fx (MM), vous pouvez configurer l'adresse uniquement via l'interrupteur DIP. Les valeurs entre parenthèses sont les paramètres d'usine.

CV	Éclairage	Valeur	
1	Adresse 1 - 255	1-255 (1)	uniquement DCC
9	Adresses 256 - 2040	0-7 (0)	uniquement DCC
39	Mouvement lent	0 (0)	
PoM*	Mouvement de vitesse moyenne	1	
	Mouvement rapide	2	
	Mouvement de vitesse moyenne avec mouvement de ressort	3	
	Mouvement de vitesse rapide avec mouvement de ressort	4	
	Mouvement de vitesse moyenne avec mouvement de ressort aile 1	5	uniquement pour 70411 / 70412
	Mouvement de vitesse moyenne avec mouvement de ressort aile 2	6	uniquement pour 70411 / 70412
40	Éclairage	0 - 15 (15)	0 lumière éteinte variateur 0-15, 15 = 100% de luminosité
PoM*			
41	Réglage moyen aile 1	0 - 255	Réglage de la position moyenne pour l'aile de tous les signaux
PoM*			
42	Réglage moyen aile 2	0 - 255	uniquement pour 70411 / 70412 réglage de la position moyenne pour la 2e aile
PoM*			

*Vous pouvez effectuer la programmation PoM, si elle est prise en charge par le pupitre de commande, sur la voie principale.
12

Réglage et calcul des adresses supérieures à 255 (DCC) :

Par ex. adresse 1044 -> 1044:256=4,078125. Vous devez reporter la valeur avant la virgule (4) dans CV 9. Multipliez la valeur après la virgule (0,078125) par 256 0,078125x256=20. Reportez la valeur calculée 20 dans CV 1.

Élimination

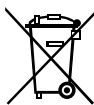

Indications relatives à la protection de l'environnement : Les produits marqués du signe représentant une poubelle barrée ne peuvent être éliminés en fin de vie via les ordures ménagères normales, mais doivent être remis à un centre de collecte pour le recyclage des appareils électriques et électroniques.

Le symbole figurant sur le produit lui-même, la notice d'utilisation ou l'emballage l'indique. Les matériaux sont recyclables selon leur marquage. Avec le recyclage, la récupération des matériaux ou autres formes de valorisation de vieux appareils, vous contribuez sensiblement à la protection de notre environnement. Renseignez-vous auprès de votre municipalité sur les centres compétents pour le traitement des déchets.

Garantie

Garantie légale et garantie contractuelle conformément au bon de garantie ci-joint.

- Pour toute réparation, veuillez vous adresser à votre détaillant spécialisé Märklin ou à
Gebr. Märklin & Cie. GmbH
Reparaturservice
Stuttgarter Str. 55 - 57
73033 Göppingen / Allemagne
☎ : +49 7161 608 222
E-mail : Service@maerklin.de

Beoogd gebruik

- Het sein is bestemd voor het inbouwen in H0-modelbanen.
- Het sein mag in analogebedrijf alleen in combinatie met het schakelkastje 72760 gebruikt worden.
- Het mag alleen in gesloten ruimtes gebruikt worden.

Leveringsomvang

- 1 Sein
- 1 Kabel met stekker 2-polig rood en bruin
- 1 Kabel met stekker 3-polig rood en rood
- 1 Kabel met stekker 3-polig violet, rood-bruin, rood-groen
- 2 Hoekhouders voor ondervloermontage
- 1 houderplaat voor C-rail
- 4 Isolaties (rood) C-rail (1 gietstuk)
- 2 Middenrail isolaties (grijs) K-rail
- 1 Middenrail aansluiting K-rail
- 1 Transfer voor herkenning
- Inbouwaanwijzing met sjabloon voor ondervloermontage
- Garantiebewijs

Voor de ondervloermontage zijn daarnaast nog nodig: een schroevendraaier, 4 verzonken schroeven \varnothing 2mm x (lengte afhankelijk van de inbouwdiepte), boor \varnothing 16 mm en 2 mm.

Veiligheidsvoorschriften

- **LET OP!** Heeft vanwege de functionaliteit scherpe kanten en punten.
- Bedrading en montagewerkzaamheden alleen in spanningloze toestand uitvoeren. Als dit niet in acht genomen wordt kunt u gevaarlijke stroomschokken krijgen met de daarmee samenhangende verwondingen.

- **Het sein alleen met de toegelaten spanning** (zie technische gegevens) **gebruiken**.

Belangrijke aanwijzingen

- De gebruiksaanwijzing is een bestandsdeel van het product en dient daarom bewaard en meegegeven worden met het product.
- Voor reparaties kunt u zich tot uw Märklin dealer wenden.
- Verwijderingaanwijzing: www.maerklin.com/en/imprint.html

Technische gegevens

- Belasting \leq 100 mA
- Belasting railuitgang max. 2 A
- Spanning max. 40 V

Funcities

- Multi-protocol geschikt voor: fx (MM) , mfx* en DCC
- Instellen van het bedrijfssysteem met dipschakelaar
- Instelbare adressen met dipschakelaars:
 - 1-256** fx (MM) (Control Unit 6021)
 - 1-320** fx (MM) (Central Station 6021x/ Mobile Station 60653)
 - 1-511** (DCC)
- Programmeerbare adressen via CV
 - 1-2040** DCC
- Veranderen van de eigenschappen via CV
- Stroomvoorziening via digitale stroomkring

Sein inbouwen

Voor het inbouwen moet het sein eerst geprogrammeerd worden.

* mfx pas vanaf CS2 softwareversie 4.0 (2 de kwartaal 2015)

De volgende werkzaamheden mogen alleen in spanningloze toestand worden uitgevoerd:

- Instellen van het adres en het bedrijfssysteem met dipschakelaar:
- Instellen van het bedrijfssysteem met dipschakelaar 10
Schakelaar 10 off = fx (MM) / mfx
Schakelaar 10 on = DCC
- fx (MM) / DCC instellen van het adres met dipschakelaar (tabel zie pagina 30)

Let op: instelling met de dipschakelaar altijd in spanningloze toestand uitvoeren. Het sein herkent de actuele instelling pas na het inschakelen van de spanning.

Programmeren met CS2

fx (MM)

De CV programmering moet op het programmeerspoor worden uitgevoerd. Er mag **altijd maar één sein** op het programmeerspoor zijn aangesloten.

De volgende CV's kunnen bij fx (MM) veranderd worden: CV 39, 40, 41 en 42. Bij de CV's 41 en 42 moet bij fx (MM) de waarde door 4 worden gedeeld omdat alleen waarden van 0-80 toelaatbaar zijn, bijv. $255/4 = 64$ (afgerond).

Tijdens het programmeren knippert het licht van het sein, afwijkend daarvan wordt tijdens het programmeren met het Central Station het sein geschakeld. Na het afsluiten van het programmeren wordt het sein in de stand "veilig" gezet.

De werkwijze voor het programmeren met de Control Unit 6021 vindt u op www.maerklin.de -> Tools & Downloads -> Technische Informationen

De wijze van programmering met andere apparaten vindt u in de

gebruiksaanwijzing van het desbetreffende apparaat.

DCC

De CV programmering moet op het programmeerspoor worden uitgevoerd. Er mag **altijd maar één sein** op het programmeerspoor zijn aangesloten.

Tijdens de overdracht van de gegevens knippert het licht van het sein ter controle.

De wijze van programmering met andere apparaten vindt u in de gebruiksaanwijzing van het desbetreffende apparaat.

Programmeren met MS2

Voor het programmeren van seinen met het Mobile Station 2 moet, onder MM2 of DCC, handmatig een nieuwe locomotief ingevoerd worden.

Let er op dat het te programmeren sein met de codeerschakelaars ook op MM2 of DCC en op hetzelfde adres ingesteld staat als de locomotief. Deze nieuw ingevoerde locomotief wordt alleen gebruikt voor het programmeren van het sein. Ga hiervoor in het menu van het MS2 naar "loc configureren" en aansluitend naar "CV programmeren".

Tijdens het programmeren mogen geen andere locomotieven, seinen of wisseldecoders aangesloten zijn.

CV voor fx (MM) en DCC

Onder fx (MM) kan het adres alleen met de dipschakelaar worden ingesteld. De waarden tussen haakjes zijn de fabrieksinstellingen.

CV	Omschrijving	Waarde	
1	Adres 1 - 255	1-255 (1)	alleen DCC

CV	Omschrijving	Waarde	
9	Adres 256 - 2040	0-7 (0)	alleen DCC
PoM*	39 Langzaam bewegen	0 (0)	
	Middel snel bewegen	1	
	Snel bewegen	2	
	Middel snel bewegen met nawippen	3	
	Snel bewegen met nawippen	4	
	Middel snel bewegen met nawippen arm 1	5	Alleen bij 70411 / 70412
	Middel snel bewegen met nawippen arm 2	6	Alleen bij 70411 / 70412
PoM*	40 Verlichting	0 - 15 (15)	0=licht uit, dimmen 0-15 waarbij 15 = 100% helderheid
PoM*	41 Middenstand arm 1	0 - 255	Instelling van de middenstand van de arm van alle seinen
PoM*	42 Middenstand arm 2	0 - 255	Alleen bij 70411/70412 Instelling van de middenstand van de 2de arm

* PoM programmeren kan, voor zover het besturingsapparaat dit ondersteund, op het hoofdspoor gebeuren.

Instellen en berekenen van de adressen groter dan 255 (DCC):

Bijv. adres 144 -> 1044:256= 4,078125. De waarde voor de komma (4) moet in CV 9 ingevoerd worden. De waarde na de komma (0,078125) wordt met 256 vermenigvuldigd, 078125x256=20. De

berekende waarde (20) wordt in CV 1 ingevoerd.

Afdanken

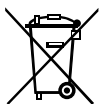

Milieu-informatie: producten, die met de doorgestreepte afvalcontainer zijn gemarkeerd, mogen aan het einde van hun levensduur niet met het normale huisvuil meegegeven worden, maar moeten op een verzamelpunt voor de recycling van elektrische en elektronische apparatuur afgegeven worden. Het symbool op het product, op de handleiding of op de verpakking geeft dit aan. De materialen worden gerecycled in overeenstemming met hun identificatie. Met het hergebruik van de grondstoffen of andere vormen van het hergebruik van oude apparatuur levert u een belangrijke bijdrage aan de bescherming van ons milieu. Neem contact op met uw gemeente voor een bevoegde plaatselijke inzamelplaats.

Garantie

Waarborg en garantie volgens bijgevoegd garantiebewijs.

- Voor reparaties kunt u zich wenden tot uw Märklin dealer of tot
Gebr. Märklin & Cie. GmbH
Reparaturservice
Stuttgarter Str. 55 - 57
73033 Göppingen
Germany
Tel: +49 7161 608 222 (Alleen buiten Duitsland)
E-Mail: Service@maerklin.de

Uso previsto

- La señal ha sido concebida para su montaje en maquetas de trenes digitales H0.
- Está permitido utilizar la señal para funcionamiento analógico solo con el panel de mando 72760.
- Está permitido su uso solo en recintos cerrados.

Alcance de suministro

- 1 señal
- 1 cable con conector de 2 polos, rojo y marrón
- 1 cable con conector de 3 polos, rojo y rojo
- 1 cable con conector de 3 polos, violeta, rojo-marrón, rojo-verde
- 2 escuadras soporte para montaje bajo el suelo
- 1 placa soporte para vía C
- 4 aislamientos (rojo) para vía C (1 pieza inyectada)
- 2 aislamientos de conductor central (gris) para vía K
- 1 toma de conductor central para vía K
- 1 juego de indicadores deslizantes para identificación
- Instrucciones de montaje con plantilla para montaje bajo el suelo.
- Documento de garantía

Herramientas también necesarias para el montaje bajo el suelo: destornillador, 4 tornillos de cabeza avellanada Ø 2,5mm x (longitud en función de la profundidad de montaje), brocas de Ø 16 mm y 2 mm.

Instrucciones de seguridad

- ¡**ATENCIÓN!** Por su funcionalidad, incluye aristas cortantes y puntas.
- Realizar los trabajos de cableado y montaje siempre sin tensión eléctrica. En caso contrario, se pueden producir peligrosas corrientes a través del cuerpo y, por tanto, lesiones físicas.

- **Asegurar que la señal funcione solo a la tensión admisible** (ver Datos técnicos).

Consejos importantes

- Las instrucciones de empleo forman parte integrante del producto y, por este motivo, deben conservarse y entregarse al nuevo comprador en el caso de venta o transmisión del producto.
- Para las reparaciones, por favor diríjase a su distribuidor Märklin.
- Eliminación: www.maerklin.com/en/imprint.html

Datos técnicos

Carga admisible	≤ 100 mA
Carga de salida de vía	máx. 2 A
Rigidez dieléctrica	máx. 40 V

Funciones

- Apta para multiprotocolo: fx (MM), mfx* y DCC
- Selección del modo de funcionamiento con microint. DIP
- Direcciones configurables con microint. DIP:
 - 1-256** fx (MM) (Control Unit 6021)
 - 1-320** fx (MM) (Central Station 6021x/Mobile Station 60653)
 - 1-511** (DCC)
- Direcciones programables vía CV
 - 1-2.040** DCC
- Modificaciones de las propiedades vía CV
- Alimentación eléctrica vía circuito digital

Montaje de la señal

Antes del montaje propiamente dicho, debe programarse la señal.

Está permitido ejecutar las siguientes operaciones únicamente sin tensión eléctrica:

Configuración de la dirección en el modo de funcionamiento mediante el microint. DIP:

- Configuración del modo de funcionamiento con microint. DIP 10
Microinterruptor 10 retirado = fx (MM) / mfx
Microinterruptor 10 colocado = DCC
- fx (MM)/DCC Configuración de la dirección con microint. DIP
(Tabla a partir de página 30)

Tenga presente lo siguiente: Realizar la configuración con el microint. DIP siempre sin tensión eléctrica. La señal no identifica las posiciones actuales del microinterruptor hasta que se activa la tensión.

Programación con CS2

fx (MM)

La programación de variables CV debe realizarse en la vía de programación. Está permitido conectar a la vía de programación **siempre solo una señal**.

En el modo fx (MM) pueden modificarse las siguientes CVs: CV 39, 40, 41 y 42. En las CV 41 y 42, en el modo fx (MM), el valor debe dividirse por 4 ya que están permitidos los valores 0-80, p. ej., $255/4 = 64$ (redondeado).

Durante la operación de programación, la lámpara de la señal destella y, a diferencia de ello, durante la operación de programación, la lámpara de la señal destella mientras que, por el contrario, durante la programación con la Central Station la señal se conmuta. Una vez finalizada la programación, se cambia la señal a «Marcha».

Encontrará el procedimiento en la programación con la Control Unit 6021 en www.maerklin.de -> Tools & Downloads -> Technische Informationen.

Para realizar la programación con otras unidades de control, consulte su manual de instrucciones de empleo.

DCC

La programación de las CVs debe realizarse en la vía de programación. Está permitido conectar a la vía de programación **siempre solo una señal**.

Durante la transmisión de datos, a modo de comprobación, luce el farol de la señal.

Para realizar la programación con otras unidades de control, consulte el manual de instrucciones de empleo de la unidad en cuestión.

Programación con la MS 2

Para programar las señales con la Mobile Station 2 se debe crear una locomotora nueva en MM2 o DCC.

En tal caso, asegúrese de que la señal a programar haya sido configurada, mediante los interruptores codificadores, también a MM2 o DCC y a la misma dirección que la locomotora. Esta locomotora nueva creada se necesita solo para la programación de las señales. Para ello, vaya a “Configurar locomotora” en el menú de la MS 2 “ y seleccione “Programar CVs”.

Durante la programación de las CVs no debe estar conectada ninguna otra locomotora, señal o decoder de desvío.

CV para fx (MM) y DCC

En fx (MM), es posible configurar la dirección solo con el microinterruptor DIP. Los valores entre paréntesis representan la

configuración de fábrica.

CV	Significado	Valores	
1	Dirección 1 - 255	1-255 (1)	solo DCC
9	Direcciones 256 - 2040	0-7 (0)	solo DCC
PoM* 39	Movimiento lento	0 (0)	
	Movimiento semirrápido	1	
	Movimiento semirrápido con rebasculación	2	
	Movimiento semirrápido con rebasculación	3	
	Movimiento rápido con rebasculación	4	
	Movimiento semirrápido con rebasculación de brazo 1	5	solo con 70411 / 70412
	Movimiento semirrápido con rebasculación de brazo 2	6	solo con 70411 / 70412
PoM* 40	Alumbrado	0 - 15 (15)	0 Luz apagada Regular intensidad a 0-15, en donde 15 equivale a brillo 100%
PoM* 41	Posición central brazo 1	0 - 255	Configuración de la posición central para el brazo de todas las señales
PoM* 42	Posición central brazo 2	0 - 255	solo en 70411 / 70412 Configuración de la posición central para el segundo brazo

*La programación en marcha PoM, siempre que así lo soporte la unidad de control, puede realizarse en la vía principal.

Configuración y cálculo de las direcciones mayores que 255 (DCC):

P. ej., dirección 1044 -> $1044:256=4,078125$. El valor antes de la coma (4) debe registrarse en la variable CV 9. El valor decimal (0.078125) se multiplica por 256 $0,078125 \times 256=20$. El valor calculado, 20, debe registrarse en la variable CV 1.

Eliminación



Indicaciones para protección del medio ambiente: Los productos identificados con el cubo de basura tachado no deben eliminarse junto con la basura doméstica normal y corriente una vez alcanzado el final de su vida útil, sino que deben entregarse en un punto de recogida para el reciclaje de equipos eléctricos y electrónicos. El símbolo que aparece en el producto, en las instrucciones de empleo o en el embalaje hace referencia a ello. Los materiales son reutilizables conforme a su identificación. Con la reutilización, el aprovechamiento de los materiales u otras formas de reciclado de aparatos viejos hacemos una aportación importante a la protección del medio ambiente. Consulte en su Ayuntamiento cuál es la entidad de recogida competente.

Garantía

La garantía legal y la garantía del fabricante se basan en el documento de garantía adjunto.

- Para reparaciones, dirijase a su distribuidor profesional de Märklin-
o a
Gebr. Märklin & Cie. GmbH
Reparaturservice
Stuttgarter Str. 55 - 57
73033 Göppingen
Alemania
Tel: +49 7161 608 222 (sólo desde fuera de Alemania)
E-Mail: Service@maerklin.de

Impiego commisurato alla destinazione

- Tale segnale è da installare in impianti di ferrovia in miniatura H0 digitali.
- Per il funzionamento analogico tale segnale deve venire impiegato solo con il quadro di comando 72760.
- Deve venire utilizzato soltanto in ambienti chiusi.

Corredo di fornitura

- 1 segnale
- 1 cavetto con spina a 2 poli, rosso e marrone
- 1 cavetto con spina a 3 poli, rosso e rosso
- 1 cavetto con spina a 3 poli, violetto, rosso-marrone, rosso-verde
- 2 squadrette di supporto per montaggio sotto plancia
- 1 piastra di supporto per binario C
- 4 isolamenti (rossi) per binario C (1 pressofusione)
- 2 isolamenti per conduttore centrale (grigio) per binario K
- 1 connessione per conduttore centrale per binario K
- 1 figure trasferibili per identificazione
- Istruzioni di montaggio con mascherina per montaggio sotto plancia
- Certificato di garanzia

Per il montaggio sotto plancia, attrezzi aggiuntivi necessari: cacciavite, 4x viti a testa svasata Ø 2,5mm x (lunghezza dipendente dalla profondità di montaggio), punte da trapano Ø 16mm e 2mm.

Avvertenze di sicurezza

- **ATTENZIONE!** Bordi e spigoli acuminati per necessità funzionali.
- Eseguire i lavori di cablaggio e montaggio soltanto nelle condizioni di assenza di tensione. In caso di mancato rispetto, questo può portare a pericolose correnti corporee e pertanto a ferimenti.

- **Si faccia funzionare il segnale solamente con la tensione ammissibile** (si vedano i dati tecnici).

Avvertenze importanti

- Le istruzioni di impiego costituiscono parte integrante del prodotto e devono pertanto venire conservate con cura nonché consegnate insieme in caso di cessione a terzi del prodotto.
- Per riparazioni Vi preghiamo di rivolgerVi al Vostro rivenditore specialista Märklin.
- Smaltimento: www.maerklin.com/en/imprint.html

Dati tecnici

- Carico ≤ 100 mA
- Carico all'uscita per il binario max. 2 A
- Resistenza alla tensione max. 40 V

Funzioni

- Adatto a protocolli multipli: fx (MM), mfx* e DCC
- Impostazione del tipo di esercizio a mezzo commutatore DIP
- Indirizzi impostabili con commutatore DIP:
1-256 fx (MM) (Control Unit 6021)
1-320 fx (MM) (Central Station 6021x/Mobile Station 60653)
1-511 (DCC)
- Indirizzi programmabili tramite le CV
1-2.040 DCC
- Variazioni delle caratteristiche tramite le CV
- Alimentazione di corrente tramite circuito di corrente digitale
- Illuminazione del segnale disattivabile oppure attivabile

Montaggio del segnale

Prima del vero e proprio montaggio il segnale deve venire programmato.

I seguenti passi del lavoro devono venire eseguiti soltanto nelle condizioni esenti da tensione:

Impostazione dell'indirizzo e del tipo di funzionamento mediante il commutatore DIP:

- Impostazione del tipo di funzionamento con commutatore DIP 10
Commutatore 10 off = fx (MM) / mfx
Commutatore 10 on = DCC
- fx (MM)/DCC impostazione dell'indirizzo con commutatore DIP (Tabella da pagina 30)

Prestate attenzione: Intraprendere le impostazioni con il commutatore DIP-Schalter sempre senza tensione. Il segnale riconosce le disposizioni attuali del commutatore solo con l'accensione della tensione.

Programmazione con CS 2

fx (MM)

La programmazione delle CV deve avvenire sul binario di programmazione. Al binario di programmazione deve venire collegato **sempre soltanto un segnale**.

Le seguenti CV possono venire modificate nel caso di fx (MM): CV 39, 40, 41 e 42. Nelle CV 41 e 42 in caso di fx (MM) il valore deve venire diviso per 4, poiché sono consentiti valori 0-80, ad es. $255/4 = 64$ (arrotondato).

Durante la procedura di programmazione la luce del segnale lampeggia, in modo differente da ciò durante la programmazione

con la Central Station il segnale è acceso. Dopo la conclusione del procedimento di programmazione il segnale viene disposto su „via libera“.

Il procedimento durante la programmazione con la Control Unit 6021 potete trovarlo su www.maerklin.de -> Tools & Downloads -> Technische Informationen.

La programmazione con altri apparati siete pregati di desumerla dalle istruzioni di azionamento del rispettivo apparato di controllo.

DCC

La programmazione delle CV deve avvenire sul binario di programmazione. Al binario di programmazione deve venire collegato **sempre soltanto un segnale**.

Durante il trasferimento dei dati per controllo lampeggia il fanale sul segnale.

La programmazione con altri apparati siete pregati di desumerla dalle istruzioni di azionamento del rispettivo apparato di controllo.

Programmazione con MS 2

Per la programmazione dei segnali con la Mobile Station 2 deve venire definita manualmente una nuova locomotiva sotto MM2 oppure DCC. Si prega di prestare attenzione al fatto che poi anche il segnale da programmare mediante il commutatore di codifica sia stato impostato su MM2 oppure DCC, sullo stesso indirizzo come tale locomotiva. Questa locomotiva definita come nuova è necessaria soltanto per la programmazione del segnale. A tale scopo andate nel Menù della MS 2 su „Configurazione loco“ e successivamente su „Programmazione CV“. Durante

tale programmazione delle CV non deve essere collegata alcuna altra locomotiva, segnale oppure Decoder per deviatoti.

CV per fx (MM) e DCC

Sotto fx (MM) l'indirizzo può venire impostato solo con il commutatore DIP. I valore in parentesi sono le impostazioni di fabbrica.

CV	Significato	Valore	
1	Indirizzi 1 - 255	1-255 (1)	solo DCC
9	Indirizzi 256 - 2040	0-7 (0)	solo DCC
39 PoM*	Movimento lento	0 (0)	
	Movimento a media velocità	1	
	Movimento rapido	2	
	Movimento a media velocità con rimbalzo	3	
	Movimento rapido con rimbalzo	4	
	Movimento a media velocità con rimbalzo ala 1	5	solo nel caso 70411 / 70412
	Movimento a media velocità con rimbalzo ala 2	6	solo nel caso 70411 / 70412
40 PoM*	Illuminazione	0 - 15 (15)	0 luce spenta attenuazione 0-15, dove 15 = 100% uguale a luminosità
41 PoM*	Posizione media ala 1	0 - 255	Impostazione della posizione media per le ali di tutti i segnali

CV	Significato	Valore	
42 PoM*	Posizione media ala 2	0 - 255	solo nel caso 70411 / 70412 Impostazione della posizione media per la 2ª ala

*La programmazione PoM avviene sul binario principale, purché essa venga supportata all'apparato di comando.

Impostazione e calcolo degli indirizzi maggiori di 255 (DCC):

Ad es. indirizzo 1044 -> $1044:256=4,078125$. Il valore prima della virgola (4) viene inserito in CV 9. Il valore dopo la virgola (0,078125) viene moltiplicato per 256: $0,078125 \times 256 = 20$. Il valore calcolato 20 deve venire inserito nella CV 1.

Smaltimento

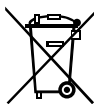

Avvertenze per la salvaguardia ambientale: i prodotti che sono contraddistinti con la pattumiera cancellata, alla fine della loro durata di vita non devono venire smaltiti tramite i normali rifiuti domestici, bensì devono venire conferiti ad un punto di raccolta per il riciclo di apparecchi elettrici ed elettronici. Tale simbolo sul prodotto, sulle istruzioni di impiego oppure sulla confezione dà avviso di questo. I materiali sono nuovamente utilizzabili in conformità al loro simbolo di riconoscimento. Con il riutilizzo, la valorizzazione dei materiali oppure altre forme di recupero degli apparecchi vecchi Voi fornite un importante contributo alla salvaguardia del nostro ambiente. Vi preghiamo di chiedere presso la Vostra amministrazione municipale i punti di smaltimento autorizzati.

Garanzia

Prestazioni di garanzia e garanzie in conformità all'accluso certificato di garanzia.

- Per riparazioni Vi preghiamo di rivolgerVi al Vostro rivenditore specialista Märklin oppure a
Gebr. Märklin & Cie. GmbH
Reparaturservice
Stuttgarter Str. 55 - 57
73033 Göppingen
Deutschland
Tel: +49 7161 608 222 (solo da fuori dell Germania)
E-Mail: Service@maerklin.de

Användningsområde

- Signal avsedd för inbyggnad i digitala H0-modelljärnvägar.
- Vid analog drift får signalen endast användas tillsammans med ställpult nr 72760.
- Signalen får endast användas i torra utrymmen.

Innehåll

- 1 Signal
- 1 Kabel med 2-polig stickkontakt, röd och brun
- 1 Kabel med 3-polig stickkontakt, röd och röd
- 1 Kabel med 3-polig stickkontakt, violett, röd-brun, röd-grön
- 2 Vinkelhållare för montage under anläggningen
- 1 Fästesplatta för C-räls
- 4 Isoleringar (röda) för C-räls (1 sats m. 4 st)
- 2 Mittledar-isoleringar (grå) för K-räls
- 1 Mittledar-anslutning för K-räls
- 1 Dekal för uppmärklning
- 1 Bruksanvisning med schablon för montage på anläggningens undersida
- 1 Garantisedel

För montage på anläggningens undersida behöver man följande verktyg: Skruvmejsel, 4 X skruvar med försänkskalle \varnothing 2,5 mm x (längden beroende på underlagets tjocklek), borr med \varnothing 16 mm och \varnothing 2 mm.

Säkerhetsföreskrifter

- **WARNING!** Funktionsbetingade vassa kanter och spetsar.
- **OBS!** Risk för farliga elstötar och risk för kroppsskada! Infästning av kablar, elanslutningar och montage får därför endast göras i spänningslöst tillstånd.

- **Signalen får endast matas med tillåten/korrekt spänning!** (Se tekniska data i bruksanvisningen.)

Viktig information

- Bruksanvisningen är en del av denna produkt och måste därför sparas och den skall medfölja vid överlåtelse av produkten till tredje man.
- För ev. reparation måste man vända sig till sin Märklin-fackhandlare.
- För hantering som avfall v.g. se: www.maerklin.com/en/im-print.html

Tekniska data

- Belastning \leq 100 mA
- Belastning spårutgång max. 2 A
- Spänning max. 40 V

Funktioner

- Anpassade för multiprotokoll:fx (MM), mfx* och DCC
- Inställning av drifttyp görs med DIP-switchar
- Inställbara adresser med DIP-switchar:
 - 1-256** fx (MM) (ControlUnit 6021)
 - 1-320** fx (MM) (Central Station 6021x/Mobile Station 60653)
 - 1-511** (DCC)
- Programmerbara adresser via CV
 - 1-2.040** DCC
- Ändring av egenskaper via CV
- Strömförsörjning via den digitala strömkretsen

Signal-inbyggnad

Innan signalen byggs in/kopplas in i anläggningen måste den programmeras.

Följande arbetsmoment får endast utföras i spänningslöst tillstånd:

Inställning av adresser och drifttyp med DIP-switchar:

- Inställning av drifttyp med DIP-switch 10
Switch 10 off = fx (MM) / fx
Switch 10 on = DCC
- fx (MM)/DCC inställning av adresser med DIP-switchar (tabeller på sidan 30)

Observera: Inställningar med DIP-switchar får endast göras i spänningslöst tillstånd! Signalen visar den aktuella inställningen först efter att elspänningen anslutits.

Programmering med CS 2

fx (MM)

CV-programmering måste göras via programmeringsspåret.

OBS! Endast en enda signal i taget får anslutas till programmeringsspåret.

Följande CV kan ändras med fx (MM): CV 39, 40, 41 och 42. Betr. CV 41 och 42 måste med fx (MM) värdet delas med 4, eftersom värdena 0 - 80 finns tillgängliga, t.ex. $255/4 = 64$ (avrundat).

Under pågående programmering blinkar signalens lyktor, ev. avvikelser under programmeringen kan ändras med Central Station. Efter avslutad programmering är signalen ställd på "kör".

Hur programmering genomförs med hjälp av Control Unit 6021 återfinns på www.maerklin.de -> Told & Downloads -> Tech-

nische Informationen.

Vid programmering med andra körkontroller: V.g. se bruksanvisningen till respektive körkontroll.

DCC

CV-programmering måste göras via programmeringsspåret.

OBS! Endast en enda signal i taget får anslutas till programmeringsspåret.

Under pågående dataöverföring blinkar som bekräftelse signalens lyktor.

Vid programmering med andra körkontroller: V.g. se bruksanvisningen till respektive körkontroll.

Programmering med MS 2

För att programmera signalerna med Mobile Station 2 måste ett nytt lokomotiv skrivas in under MM2 eller DCC.

Observera då att signalen som ska programmeras ska via decodern kodas för MM2 eller DCC, samt på samma adress som loket ställts in på. Det nyinskrivna loket används bara för programmering av signalen. Gå därför in på MS 2-menyn, "konfiguration av lok" och därefter på "CV-programmering".

Under CV-programmeringen får inga andra lok, signaler eller växeldekodrar vara anslutna eller aktiverade.

CV för fx (MM) och DCC

under fx (MM) kan adresserna endast ställas in med DIP-switcharna. Angivna värden inom klammer är fabriksinställningar.

CV	Innebörd	Värde	
1	Adresser 1 - 255	1-255 (1)	endast DCC
9	Adresser 256 - 2040	0-7 (0)	endast DCC

CV	Innebörd	Värde	
39	Långsam rörelse	0 (0)	
PoM*	Medelsnabb rörelse	1	
	Snabb rörelse	2	
	Medelsnabb rörelse med omställning	3	
	Snabb rörelse med omställning	4	
	Medelsnabb rörelse med omställning vinge 1	5	endast för 70411 / 70412
	Medelsnabb rörelse med omställning vinge 2	6	endast för 70411 / 70412
40	Belysning	0 - 15 (15)	0 ljuset släckt dimmer 0-15, varvid 15 = 100% ljusstyrka
PoM*			
41	Mellanläge vinge 1	0 - 255	Inställning av mellanläge för samtliga signalers vingar
PoM*			
42	Mellanläge vinge 2	0 - 255	endast för 70411/70412 inställning av mellanläge för vinge 2
PoM*			

*PoM programmering kan, om körkontrollen tillåter detta, göras via anläggningens huvudspår.

Inställning och beräkning av adresser större än 255 (DCC):
T.ex. Adress 1044 -> $1044:256=4,078125$. Värdet efter komma-

tecknet (0,078125) multipliceras med 256 $0,078125 \times 256 = 20$. Det framräknade värdet måste tas in i CV 1.

Källsortering



Observera miljöskyddsbestämmelserna: Produkter märkta med symbolen som föreställer en överkorsad soptunna, får när de förbrukats inte hanteras som normalt hushållsavfall, utan skall lämnas in till en återvinningsstation som tar emot kasserade elapparater och elektronikavfall. Återvinning av materialet i sådana förbrukade apparater och elektronik är ett viktigt bidrag till miljöskyddet. Vid tveksamhet: Kontakta miljöskyddet i din hemkommun och fråga efter en återvinningsstation som tar emot el- och elektronikavfall.

Garanti

Omfattning av tillverkaransvar och garantier framgår av bifogad garantisedel.

- För reparationer vänder man sig till sin Märklin-fackhandel eller till
Gebr. Märklin & Cie. GmbH
Reparaturservice
Stuttgarter Str. 55 - 57
73033 Göppingen
Tyskland
Tel: +49 7161 608 222
Email: Service@maerklin.de

Hensigtsmæssig anvendelse

- Signalet er til indbygning i H0 digital-modelbaneanlæg.
- Signalet må til analogdrift kun anvendes med kontrolpanel 72760.
- Må kun anvendes i lukkede rum.

Leveringsomfang

- 1 signal
- 1 kabel med stik, 2-polet, rød og brun
- 1 kabel med stik, 3-polet, rød og rød
- 1 kabel med stik, 3-polet, violet, rød-brun, rød-grøn
- 2 holdebeslag til underhængt montering
- 1 holdeplads C-skinne
- 4 isoleringer (rød) C-skinne (1støbt)
- 2 mellemleder-isoleringer (grå) K-skinne
- 1 mellemleder-tilslutning K-skinne
- 1 overføringsbillede til mærkning
- Indbygningsvejledning med skabelon til underhængt montering
- Garantibevis

Værktøj, der skal bruges til underhængt montering: Skruetrækker, 4x nedsænkningsskruer \varnothing 2,5 mm x (længden afhænger af indbygningsdybden), bor \varnothing 16 mm og 2mm.

Sikkerhedsvejledning

- **BEMÆRK!** Funktionsbetingede skarpe kanter og spidser.
- Kabel- og monteringsopgaver må udelukkende foretages i spændingsfri tilstand. Manglende overholdelse kan føre til farlig strøm gennem kroppen og skader.
- **Signalet må kun drives med den tilladte spænding** (se tekniske data).

Vigtig information

- Betjeningsvejledningen er del af produktet og skal derfor opbevares sammen med produktet og gives videre til tredje-mand sammen med produktet.
- Kontakt din Märklin-forhandler for reparationer.
- Bortskaffelse: www.maerklin.com/en/imprint.html

Tekniske data

- Belastning \leq 100 mA
- Belastning skinneudgang maks. 2 A
- Holdespænding maks. 40 V

Funktioner

- Mulig multiprotokol: fx (MM), mfx* og DCC
- Indstilling af driftsform ved hjælp af DIP-kontakt
- Indstilling af adresser ved hjælp af DIP-kontakt:
 - 1-256** fx (MM) (Control Unit 6021)
 - 1-320** fx (MM) (Central Station 6021x/Mobile Station 60653)
 - 1-511** (DCC)
- Programmérbare adresser via CV
 - 1-2.040** DCC
- Ændring af egenskaber via CV
- Strømforsyning via digitalstrømkreds

Signalindbygning

Signalet skal programmeres inden indbygning.

Følgende arbejdsstrin må kun udføres i spændingsfri tilstand:

* mfx først fra CS2 Softwareversion 4.0 (2. kvartal 2015)

Indstilling af adresser og driftsform via DIP-kontakten:

- Indstilling af driftsform ved hjælp af DIP-kontakt 10
Kontakt 10 off = fx (MM) / mfx
Kontakt 10 on = DCC
- fx (MM)/DCC indstilling af adresser med DIP-kontakt (tabel fra side 30)

Bemærk: Indstillinger med DIP-kontakten skal altid foretages i spændingsfri tilstand. Signalet genkender først den aktuelle kontaktindstilling, når spændingen aktiveres.

Programmering med CS 2

fx (MM)

CV-programmeringen skal foretages på programmeringsskinen. Der må altid **kun tilsluttes et signal** på programmeringsskinen.

Følgende CV'er kan ændres ved fx (MM): CV 39, 40, 41 og 42.

Ved CV 41 og 42, skal ved fx (MM) værdien deles med 4, for kun værdierne 0-80 er tilladte, f. eks. $255/4 = 64$ (afrundet).

Signallampen blinker under programmeringen; uafhængigt deraf aktiveres signalet med Central Station under programmeringen. Efter afsluttet programmering, indstilles signalet på „Kørsel“.

Fremgangsmåden til programmering med Control Unit 6021 findes på www.maerklin.de -> Tools & Downloads -> Technische Informationen.

Beskrivelse af programmeringen med andre enheder findes i betjeningsvejledningen for den pågældende styreenhed.

DCC

CV-programmeringen skal foretages på programmeringsskinen. Der må altid **kun tilsluttes et signal** på programmeringsskinen.

Signalets lampe blinker til kontrol under hele dataoverførslen. Beskrivelse af programmeringen med andre enheder findes i betjeningsvejledningen for den pågældende styreenhed.

Programmering med MS 2

Til programmering af signaler med Mobile Station 2 skal der oprettes et nyt lokomotiv manuelt under MM2 eller DCC. Bemærk venligst, at det programmerede signal over koderingskontakten så også bliver indstillet på MM2 eller DCC samt den samme adresse som lokomotivet. Det nyoprettede lokomotiv skal kun bruges til programmering af signaler. Åbn dertil menuen på MS 2 og gå til "Konfiguration af lokomotiv" og derefter "Programmering af CV".

Der må ikke være tilsluttet andre lokomotiver, signaler eller sporskiftedekodere under CV-programmeringen.

CV til fx (MM) og DCC

Under fx (MM) kan adressen kun indstilles med DIP-kontakten. Værdier i parentes er fabriksindstillingerne.

CV	Betydning	Værdier	
1	Adresse 1 - 255	1-255 (1)	kun DCC
9	Adresser 256 - 2040	0-7 (0)	kun DCC

CV	Betydning	Værdier	
39 PoM*	Langsom bevægelse	0 (0)	
	Mellemløst hurtig bevægelse	1	
	Hurtig bevægelse	2	
	Mellemløst hurtig bevægelse med eftervip	3	
	Hurtig bevægelse med eftervip	4	
	Mellemløst hurtig bevægelse med eftervip Vinge 1	5	kun for 70411 / 70412
	Mellemløst hurtig bevægelse med eftervip Vinge 2	6	kun for 70411 / 70412
40 PoM*	Belysning	0 - 15 (15)	0 lys fra dimmer 0-15, hvor 15 = svarer til 100 % lysshed
41 PoM*	Mellemstilling Vinge 1	0 - 255	Indstilling af mellemposition af alle signalers vinger
42 PoM*	Mellemstilling Vinge 2	0 - 255	kun for 70411 / 70412 Indstilling af mellemposition for 2. vinge

*PoM kan programmeres på hovedskinne, hvis det understøttes af styreenheden.

Indstilling og beregning af adresser større end 255 (DCC):

F. eks. adresse 1044 -> $1044:256=4,078125$. Værdien før komma (4) skal indtastes i CV 9. Værdien efter komma (0,078125) ganges med 256 ($0,078125 \times 256=20$). Den beregnede værdi 20 indtastes i CV 1.

Bortskaffelse

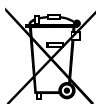

Bemærkninger om miljøbeskyttelse: Produkter, der er mærket med en overstreget affaldsspand, må ved slutningen af deres levetid ikke bortskaffes med det normale husholdningsaffald, men skal afleveres ved et indsamlingssted for genbrug af elektrisk og elektronisk udstyr. Symbolet på produktet, betjeningsvejledningen eller emballagen gør opmærksom på det. Materialerne kan genbruges jævnfør deres mærkning. Med genbrug, ophug eller andre former for udnyttelse af udtjent udstyr yder du et vigtigt bidrag til beskyttelse af miljøet. Spørg hos din kommune, hvor du finder det rigtige afleveringssted.

Garanti

Garanti jævnfør vedlagte garantibevis.

- For reparationer bedes du venligst henvende dig til din Märklin forhandler eller til Gebr. Märklin & Cie. GmbH
Reparaturservice
Stuttgarter Str. 55 - 57
73033 Göppingen
Tyskland
Tel: +49 7161 608 222 (kun fra uden for Tyskland)
E-Mail: Service@maerklin.de

Betriebsart und Adressen einstellen

Setting the mode of operation and addresses

Définir le mode d'exploitation et les adresses

Bedrijfsmodus en adres instellen



Configuración de modo de funcionamiento y direcciones



Impostate tipo di funzionamento e indirizzi

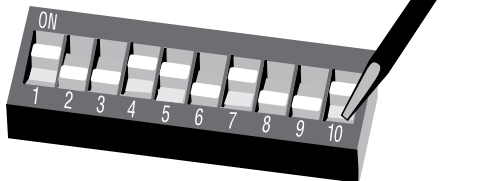

Ställ in driftstyp och adress



Indstil driftsart og adresser





										10 (0/1)	
1	1	1	1							fx (MM)/DCC	
2	1	2	2							fx (MM)/DCC	
3	1	3	1 2							fx (MM)/DCC	
4	1	4		3						fx (MM)/DCC	
5	1	5	1 3							fx (MM)/DCC	
6	1	6		2 3						fx (MM)/DCC	
7	1	7	1 2 3							fx (MM)/DCC	
8	1	8			4					fx (MM)/DCC	
9	1	9	1		4					fx (MM)/DCC	
10	1	10		2 4						fx (MM)/DCC	
11	1	11	1 2	4						fx (MM)/DCC	
12	1	12		3 4						fx (MM)/DCC	
13	1	13	1	3 4						fx (MM)/DCC	
14	1	14		2 3 4						fx (MM)/DCC	
15	1	15	1 2 3 4							fx (MM)/DCC	
16	1	16			5					fx (MM)/DCC	
17	2	1	1		5					fx (MM)/DCC	
18	2	2		2	5					fx (MM)/DCC	
19	2	3	1 2		5					fx (MM)/DCC	
20	2	4		3 5						fx (MM)/DCC	
21	2	5	1	3 5						fx (MM)/DCC	
22	2	6		2 3 5						fx (MM)/DCC	
23	2	7	1 2 3		5					fx (MM)/DCC	
24	2	8			4 5					fx (MM)/DCC	
25	2	9	1		4 5					fx (MM)/DCC	
26	2	10		2 4 5						fx (MM)/DCC	

				10 (0/1)						
27		2	11	1	2	4	5	fx (MM)/DCC		
28		2	12			3	4	5	fx (MM)/DCC	
29		2	13	1		3	4	5	fx (MM)/DCC	
30		2	14			2	3	4	5	fx (MM)/DCC
31		2	15	1	2	3	4	5	fx (MM)/DCC	
32		2	16					6	fx (MM)/DCC	
33		3	1	1				6	fx (MM)/DCC	
34		3	2		2			6	fx (MM)/DCC	
35		3	3	1	2			6	fx (MM)/DCC	
36		3	4			3		6	fx (MM)/DCC	
37		3	5	1		3		6	fx (MM)/DCC	
38		3	6			2	3	6	fx (MM)/DCC	
39		3	7	1	2	3		6	fx (MM)/DCC	
40		3	8				4	6	fx (MM)/DCC	
41		3	9	1			4	6	fx (MM)/DCC	
42		3	10		2		4	6	fx (MM)/DCC	
43		3	11	1	2		4	6	fx (MM)/DCC	
44		3	12			3	4	6	fx (MM)/DCC	
45		3	13	1		3	4	6	fx (MM)/DCC	
46		3	14			2	3	4	6	fx (MM)/DCC
47		3	15	1	2	3	4	6	fx (MM)/DCC	
48		3	16					5	6	fx (MM)/DCC
49		4	1	1				5	6	fx (MM)/DCC
50		4	2		2			5	6	fx (MM)/DCC
51		4	3	1	2			5	6	fx (MM)/DCC



				10 (0/1)							
52		4	4			3	5	6	fx (MM)/DCC		
53		4	5	1		3	5	6	fx (MM)/DCC		
54		4	6		2	3	5	6	fx (MM)/DCC		
55		4	7	1	2	3	5	6	fx (MM)/DCC		
56		4	8				4	5	6	fx (MM)/DCC	
57		4	9	1			4	5	6	fx (MM)/DCC	
58		4	10		2		4	5	6	fx (MM)/DCC	
59		4	11	1	2		4	5	6	fx (MM)/DCC	
60		4	12			3	4	5	6	fx (MM)/DCC	
61		4	13	1		3	4	5	6	fx (MM)/DCC	
62		4	14			2	3	4	5	6	fx (MM)/DCC
63		4	15	1	2	3	4	5	6	fx (MM)/DCC	
64		4	16						7	fx (MM)/DCC	
65		5	1	1					7	fx (MM)/DCC	
66		5	2		2				7	fx (MM)/DCC	
67		5	3	1	2				7	fx (MM)/DCC	
68		5	4			3			7	fx (MM)/DCC	
69		5	5	1		3			7	fx (MM)/DCC	
70		5	6			2	3		7	fx (MM)/DCC	
71		5	7	1	2	3			7	fx (MM)/DCC	
72		5	8				4		7	fx (MM)/DCC	
73		5	9	1			4		7	fx (MM)/DCC	
74		5	10			2	4		7	fx (MM)/DCC	
75		5	11	1	2		4		7	fx (MM)/DCC	
76		5	12			3	4		7	fx (MM)/DCC	



										10 (0/1)
	77	5 13	1	3 4	7	fx (MM)/DCC				
78	5 14	2 3 4	7	fx (MM)/DCC						
79	5 15	1 2 3 4	7	fx (MM)/DCC						
80	5 16	5 7	fx (MM)/DCC							
81	6 1 1	5 7	fx (MM)/DCC							
82	6 2	2 5 7	fx (MM)/DCC							
83	6 3	1 2 5 7	fx (MM)/DCC							
84	6 4	3 5 7	fx (MM)/DCC							
85	6 5	1 3 5 7	fx (MM)/DCC							
86	6 6	2 3 5 7	fx (MM)/DCC							
87	6 7	1 2 3 5 7	fx (MM)/DCC							
88	6 8	4 5 7	fx (MM)/DCC							
89	6 9	1 4 5 7	fx (MM)/DCC							
90	6 10	2 4 5 7	fx (MM)/DCC							
91	6 11	1 2 4 5 7	fx (MM)/DCC							
92	6 12	3 4 5 7	fx (MM)/DCC							
93	6 13	1 3 4 5 7	fx (MM)/DCC							
94	6 14	2 3 4 5 7	fx (MM)/DCC							
95	6 15	1 2 3 4 5 7	fx (MM)/DCC							
96	6 16	6 7	fx (MM)/DCC							
97	7 1	1 6 7	fx (MM)/DCC							
98	7 2	2 6 7	fx (MM)/DCC							
99	7 3	1 2 6 7	fx (MM)/DCC							
100	7 4	3 6 7	fx (MM)/DCC							
101	7 5	1 3 6 7	fx (MM)/DCC							



										10 (0/1)
	102	7 6	2 3	6 7	fx (MM)/DCC					
103	7 7	1 2 3	6 7	fx (MM)/DCC						
104	7 8	4 6 7	fx (MM)/DCC							
105	7 9	1 4 6 7	fx (MM)/DCC							
106	7 10	2 4 6 7	fx (MM)/DCC							
107	7 11	1 2 4 6 7	fx (MM)/DCC							
108	7 12	3 4 6 7	fx (MM)/DCC							
109	7 13	1 3 4 6 7	fx (MM)/DCC							
110	7 14	2 3 4 6 7	fx (MM)/DCC							
111	7 15	1 2 3 4 6 7	fx (MM)/DCC							
112	7 16	5 6 7	fx (MM)/DCC							
113	8 1	1 5 6 7	fx (MM)/DCC							
114	8 2	2 5 6 7	fx (MM)/DCC							
115	8 3	1 2 5 6 7	fx (MM)/DCC							
116	8 4	3 5 6 7	fx (MM)/DCC							
117	8 5	1 3 5 6 7	fx (MM)/DCC							
118	8 6	2 3 5 6 7	fx (MM)/DCC							
119	8 7	1 2 3 5 6 7	fx (MM)/DCC							
120	8 8	4 5 6 7	fx (MM)/DCC							
121	8 9	1 4 5 6 7	fx (MM)/DCC							
122	8 10	2 4 5 6 7	fx (MM)/DCC							
123	8 11	1 2 4 5 6 7	fx (MM)/DCC							
124	8 12	3 4 5 6 7	fx (MM)/DCC							
125	8 13	1 3 4 5 6 7	fx (MM)/DCC							
126	8 14	2 3 4 5 6 7	fx (MM)/DCC							
127	8 15	1 2 3 4 5 6 7	fx (MM)/DCC							



Key	Keyboard		ON							10 (0/1)	Function			
	0	1	1	2	3	4	5	6	7			8	9	0
128	8	16											8	fx (MM)/DCC
129	9	1	1										8	fx (MM)/DCC
130	9	2		2									8	fx (MM)/DCC
131	9	3	1	2									8	fx (MM)/DCC
132	9	4			3								8	fx (MM)/DCC
133	9	5	1	3									8	fx (MM)/DCC
134	9	6		2	3								8	fx (MM)/DCC
135	9	7	1	2	3								8	fx (MM)/DCC
136	9	8				4							8	fx (MM)/DCC
137	9	9	1			4							8	fx (MM)/DCC
138	9	10		2		4							8	fx (MM)/DCC
139	9	11	1	2		4							8	fx (MM)/DCC
140	9	12			3	4							8	fx (MM)/DCC
141	9	13	1		3	4							8	fx (MM)/DCC
142	9	14		2	3	4							8	fx (MM)/DCC
143	9	15	1	2	3	4							8	fx (MM)/DCC
144	9	16					5						8	fx (MM)/DCC
145	10	1	1				5						8	fx (MM)/DCC
146	10	2		2			5						8	fx (MM)/DCC
147	10	3	1	2			5						8	fx (MM)/DCC
148	10	4			3		5						8	fx (MM)/DCC
149	10	5	1		3		5						8	fx (MM)/DCC
150	10	6		2	3		5						8	fx (MM)/DCC
151	10	7	1	2	3		5						8	fx (MM)/DCC
152	10	8				4	5						8	fx (MM)/DCC
153	10	9	1			4	5						8	fx (MM)/DCC



Key	Keyboard		ON							10 (0/1)	Function			
	0	1	1	2	3	4	5	6	7			8	9	0
154	10	10		2		4	5						8	fx (MM)/DCC
155	10	11	1	2		4	5						8	fx (MM)/DCC
156	10	12			3	4	5						8	fx (MM)/DCC
157	10	13	1		3	4	5						8	fx (MM)/DCC
158	10	14		2	3	4	5						8	fx (MM)/DCC
159	10	15	1	2	3	4	5						8	fx (MM)/DCC
160	10	16						6					8	fx (MM)/DCC
161	11	1	1					6					8	fx (MM)/DCC
162	11	2		2				6					8	fx (MM)/DCC
163	11	3	1	2				6					8	fx (MM)/DCC
164	11	4			3			6					8	fx (MM)/DCC
165	11	5	1		3			6					8	fx (MM)/DCC
166	11	6		2	3			6					8	fx (MM)/DCC
167	11	7	1	2	3			6					8	fx (MM)/DCC
168	11	8				4		6					8	fx (MM)/DCC
169	11	9	1			4		6					8	fx (MM)/DCC
170	11	10		2		4		6					8	fx (MM)/DCC
171	11	11	1	2		4		6					8	fx (MM)/DCC
172	11	12			3	4		6					8	fx (MM)/DCC
173	11	13	1		3	4		6					8	fx (MM)/DCC
174	11	14		2	3	4		6					8	fx (MM)/DCC
175	11	15	1	2	3	4		6					8	fx (MM)/DCC
176	11	16					5	6					8	fx (MM)/DCC
177	12	1	1				5	6					8	fx (MM)/DCC
178	12	2		2			5	6					8	fx (MM)/DCC
179	12	3	1	2			5	6					8	fx (MM)/DCC



										10 (0/1)
			1	2	3	4	5	6	7	
180		12 4			3	5 6	8		fx (MM)/DCC	
181		12 5	1		3	5 6	8		fx (MM)/DCC	
182		12 6		2 3		5 6	8		fx (MM)/DCC	
183		12 7	1 2 3			5 6	8		fx (MM)/DCC	
184		12 8			4 5 6	8			fx (MM)/DCC	
185		12 9	1		4 5 6	8			fx (MM)/DCC	
186		12 10		2	4 5 6	8			fx (MM)/DCC	
187		12 11	1 2		4 5 6	8			fx (MM)/DCC	
188		12 12			3 4 5 6	8			fx (MM)/DCC	
189		12 13	1		3 4 5 6	8			fx (MM)/DCC	
190		12 14		2 3 4 5 6	8				fx (MM)/DCC	
191		12 15	1 2 3 4 5 6	8					fx (MM)/DCC	
192		12 16					7 8		fx (MM)/DCC	
193		13 1	1				7 8		fx (MM)/DCC	
194		13 2		2			7 8		fx (MM)/DCC	
195		13 3	1 2				7 8		fx (MM)/DCC	
196		13 4			3		7 8		fx (MM)/DCC	
197		13 5	1 3				7 8		fx (MM)/DCC	
198		13 6		2 3			7 8		fx (MM)/DCC	
199		13 7	1 2 3				7 8		fx (MM)/DCC	
200		13 8			4		7 8		fx (MM)/DCC	
201		13 9	1		4		7 8		fx (MM)/DCC	
202		13 10		2	4		7 8		fx (MM)/DCC	
203		13 11	1 2		4		7 8		fx (MM)/DCC	
204		13 12			3 4		7 8		fx (MM)/DCC	
205		13 13	1		3 4		7 8		fx (MM)/DCC	



										10 (0/1)
			1	2	3	4	5	6	7	
206		13 14		2 3 4			7 8		fx (MM)/DCC	
207		13 15	1 2 3 4				7 8		fx (MM)/DCC	
208		13 16				5	7 8		fx (MM)/DCC	
209		14 1	1			5	7 8		fx (MM)/DCC	
210		14 2		2		5	7 8		fx (MM)/DCC	
211		14 3	1 2			5	7 8		fx (MM)/DCC	
212		14 4			3	5	7 8		fx (MM)/DCC	
213		14 5	1		3	5	7 8		fx (MM)/DCC	
214		14 6		2 3		5	7 8		fx (MM)/DCC	
215		14 7	1 2 3			5	7 8		fx (MM)/DCC	
216		14 8			4 5		7 8		fx (MM)/DCC	
217		14 9	1		4 5		7 8		fx (MM)/DCC	
218		14 10		2	4 5		7 8		fx (MM)/DCC	
219		14 11	1 2		4 5		7 8		fx (MM)/DCC	
220		14 12			3 4 5		7 8		fx (MM)/DCC	
221		14 13	1		3 4 5		7 8		fx (MM)/DCC	
222		14 14		2 3 4 5			7 8		fx (MM)/DCC	
223		14 15	1 2 3 4 5				7 8		fx (MM)/DCC	
224		14 16					6 7 8		fx (MM)/DCC	
225		15 1	1				6 7 8		fx (MM)/DCC	
226		15 2		2			6 7 8		fx (MM)/DCC	
227		15 3	1 2				6 7 8		fx (MM)/DCC	
228		15 4			3		6 7 8		fx (MM)/DCC	
229		15 5	1		3		6 7 8		fx (MM)/DCC	
230		15 6		2 3			6 7 8		fx (MM)/DCC	
231		15 7	1 2 3				6 7 8		fx (MM)/DCC	



	 keyboard	 10 (0/1)									
			232	15	8		4	6	7	8	fx (MM)/DCC
233	15	9	1		4	6	7	8	fx (MM)/DCC		
234	15	10		2	4	6	7	8	fx (MM)/DCC		
235	15	11	1	2	4	6	7	8	fx (MM)/DCC		
236	15	12			3	4	6	7	8	fx (MM)/DCC	
237	15	13	1		3	4	6	7	8	fx (MM)/DCC	
238	15	14		2	3	4	6	7	8	fx (MM)/DCC	
239	15	15	1	2	3	4		6	7	8	fx (MM)/DCC
240	15	16				5	6	7	8	fx (MM)/DCC	
241	16	1	1			5	6	7	8	fx (MM)/DCC	
242	16	2		2		5	6	7	8	fx (MM)/DCC	
243	16	3	1	2		5	6	7	8	fx (MM)/DCC	
244	16	4			3	5	6	7	8	fx (MM)/DCC	
245	16	5	1		3	5	6	7	8	fx (MM)/DCC	
246	16	6		2	3	5	6	7	8	fx (MM)/DCC	
247	16	7	1	2	3	5	6	7	8	fx (MM)/DCC	
248	16	8			4	5	6	7	8	fx (MM)/DCC	
249	16	9	1		4	5	6	7	8	fx (MM)/DCC	
250	16	10		2	4	5	6	7	8	fx (MM)/DCC	
251	16	11	1	2		4	5	6	7	8	fx (MM)/DCC
252	16	12			3	4	5	6	7	8	fx (MM)/DCC
253	16	13	1		3	4	5	6	7	8	fx (MM)/DCC
254	16	14		2	3	4	5	6	7	8	fx (MM)/DCC
255	16	15	1	2	3	4	5	6	7	8	fx (MM)/DCC
256	16	16							9	fx (MM)/DCC	
257	17	1	1						9	fx (MM)/DCC	



	 keyboard	 10 (0/1)								
			258	17	2	2			9	fx (MM)/DCC
259	17	3	1	2					9	fx (MM)/DCC
260	17	4				3			9	fx (MM)/DCC
261	17	5	1		3				9	fx (MM)/DCC
262	17	6		2	3				9	fx (MM)/DCC
263	17	7	1	2	3				9	fx (MM)/DCC
264	17	8				4			9	fx (MM)/DCC
265	17	9	1			4			9	fx (MM)/DCC
266	17	10		2	4				9	fx (MM)/DCC
267	17	11	1	2		4			9	fx (MM)/DCC
268	17	12			3	4			9	fx (MM)/DCC
269	17	13	1		3	4			9	fx (MM)/DCC
270	17	14		2	3	4			9	fx (MM)/DCC
271	17	15	1	2	3	4			9	fx (MM)/DCC
272	17	16					5		9	fx (MM)/DCC
273	18	1	1				5		9	fx (MM)/DCC
274	18	2		2			5		9	fx (MM)/DCC
275	18	3	1	2			5		9	fx (MM)/DCC
276	18	4			3	5			9	fx (MM)/DCC
277	18	5	1		3	5			9	fx (MM)/DCC
278	18	6		2	3	5			9	fx (MM)/DCC
279	18	7	1	2	3	5			9	fx (MM)/DCC
280	18	8				4	5		9	fx (MM)/DCC
281	18	9	1			4	5		9	fx (MM)/DCC
282	18	10		2		4	5		9	fx (MM)/DCC
283	18	11	1	2		4	5		9	fx (MM)/DCC



													
		10 (0/1)											
284	18	12			3	4	5				9	fx (MM)/DCC	
285	18	13	1		3	4	5				9	fx (MM)/DCC	
286	18	14		2	3	4	5				9	fx (MM)/DCC	
287	18	15	1	2	3	4	5				9	fx (MM)/DCC	
288	18	16						6			9	fx (MM)/DCC	
289	19	1	1					6			9	fx (MM)/DCC	
290	19	2		2				6			9	fx (MM)/DCC	
291	19	3	1	2				6			9	fx (MM)/DCC	
292	19	4			3			6			9	fx (MM)/DCC	
293	19	5	1		3			6			9	fx (MM)/DCC	
294	19	6		2	3			6			9	fx (MM)/DCC	
295	19	7	1	2	3			6			9	fx (MM)/DCC	
296	19	8				4		6			9	fx (MM)/DCC	
297	19	9	1			4		6			9	fx (MM)/DCC	
298	19	10		2		4		6			9	fx (MM)/DCC	
299	19	11	1	2		4		6			9	fx (MM)/DCC	
300	19	12			3	4		6			9	fx (MM)/DCC	
301	19	13	1		3	4		6			9	fx (MM)/DCC	
302	19	14		2	3	4		6			9	fx (MM)/DCC	
303	19	15	1	2	3	4		6			9	fx (MM)/DCC	
304	19	16					5	6			9	fx (MM)/DCC	
305	20	1	1				5	6			9	fx (MM)/DCC	
306	20	2		2			5	6			9	fx (MM)/DCC	
307	20	3	1	2			5	6			9	fx (MM)/DCC	
308	20	4			3		5	6			9	fx (MM)/DCC	
309	20	5	1		3		5	6			9	fx (MM)/DCC	

														
		10 (0/1)												
310	20	6			2	3			5	6		9	fx (MM)/DCC	
311	20	7	1	2	3				5	6		9	fx (MM)/DCC	
312	20	8							4	5	6		9	fx (MM)/DCC
313	20	9	1						4	5	6		9	fx (MM)/DCC
314	20	10		2					4	5	6		9	fx (MM)/DCC
315	20	11	1	2					4	5	6		9	fx (MM)/DCC
316	20	12				3	4	5	6				9	fx (MM)/DCC
317	20	13	1			3	4	5	6				9	fx (MM)/DCC
318	20	14		2	3	4	5	6					9	fx (MM)/DCC
319	20	15	1	2	3	4	5	6					9	fx (MM)/DCC
320	20	16								7			9	fx (MM)/DCC
321	21	1	1							7	9			---/DCC
322	21	2		2						7	9			---/DCC
323	21	3	1	2						7	9			---/DCC
324	21	4				3				7	9			---/DCC
325	21	5	1			3				7	9			---/DCC
326	21	6		2	3					7	9			---/DCC
327	21	7	1	2	3					7	9			---/DCC
328	21	8							4		7	9		---/DCC
329	21	9	1						4		7	9		---/DCC
330	21	10		2					4		7	9		---/DCC
331	21	11	1	2					4		7	9		---/DCC
332	21	12				3	4			7	9			---/DCC
333	21	13	1			3	4			7	9			---/DCC
334	21	14		2	3	4				7	9			---/DCC
335	21	15	1	2	3	4				7	9			---/DCC

										10 (0/1)		
336	21	16			5	7	9	---	/	DCC		
337	22	1	1		5	7	9	---	/	DCC		
338	22	2		2	5	7	9	---	/	DCC		
339	22	3	1	2	5	7	9	---	/	DCC		
340	22	4		3	5	7	9	---	/	DCC		
341	22	5	1	3	5	7	9	---	/	DCC		
342	22	6		2	3	5	7	9	---	/	DCC	
343	22	7	1	2	3	5	7	9	---	/	DCC	
344	22	8			4	5	7	9	---	/	DCC	
345	22	9	1		4	5	7	9	---	/	DCC	
346	22	10		2	4	5	7	9	---	/	DCC	
347	22	11	1	2	4	5	7	9	---	/	DCC	
348	22	12			3	4	5	7	9	---	/	DCC
349	22	13	1		3	4	5	7	9	---	/	DCC
350	22	14		2	3	4	5	7	9	---	/	DCC
351	22	15	1	2	3	4	5	7	9	---	/	DCC
352	22	16				6	7	9	---	/	DCC	
353	23	1	1			6	7	9	---	/	DCC	
354	23	2		2		6	7	9	---	/	DCC	
355	23	3	1	2		6	7	9	---	/	DCC	
356	23	4			3	6	7	9	---	/	DCC	
357	23	5	1		3	6	7	9	---	/	DCC	
358	23	6		2	3	6	7	9	---	/	DCC	
359	23	7	1	2	3	6	7	9	---	/	DCC	
360	23	8			4	6	7	9	---	/	DCC	
361	23	9	1		4	6	7	9	---	/	DCC	



										10 (0/1)				
362	23	10			2	4	6	7	9	---	/	DCC		
363	23	11	1	2	4	6	7	9	---	/	DCC			
364	23	12			3	4	6	7	9	---	/	DCC		
365	23	13	1		3	4	6	7	9	---	/	DCC		
366	23	14		2	3	4	6	7	9	---	/	DCC		
367	23	15	1	2	3	4	6	7	9	---	/	DCC		
368	23	16					5	6	7	9	---	/	DCC	
369	24	1	1				5	6	7	9	---	/	DCC	
370	24	2		2			5	6	7	9	---	/	DCC	
371	24	3	1	2			5	6	7	9	---	/	DCC	
372	24	4			3		5	6	7	9	---	/	DCC	
373	24	5	1		3		5	6	7	9	---	/	DCC	
374	24	6		2	3		5	6	7	9	---	/	DCC	
375	24	7	1	2	3		5	6	7	9	---	/	DCC	
376	24	8					4	5	6	7	9	---	/	DCC
377	24	9	1				4	5	6	7	9	---	/	DCC
378	24	10		2			4	5	6	7	9	---	/	DCC
379	24	11	1	2			4	5	6	7	9	---	/	DCC
380	24	12			3	4	5	6	7	9	---	/	DCC	
381	24	13	1		3	4	5	6	7	9	---	/	DCC	
382	24	14		2	3	4	5	6	7	9	---	/	DCC	
383	24	15	1	2	3	4	5	6	7	9	---	/	DCC	
384	24	16							8	9	---	/	DCC	
385	25	1	1						8	9	---	/	DCC	
386	25	2		2					8	9	---	/	DCC	
387	25	3	1	2					8	9	---	/	DCC	

													
												10 (0/1)	
388	25	4			3					8	9		---/DCC
389	25	5	1		3					8	9		---/DCC
390	25	6		2	3					8	9		---/DCC
391	25	7	1	2	3					8	9		---/DCC
392	25	8				4				8	9		---/DCC
393	25	9	1			4				8	9		---/DCC
394	25	10		2		4				8	9		---/DCC
395	25	11	1	2		4				8	9		---/DCC
396	25	12			3	4				8	9		---/DCC
397	25	13	1		3	4				8	9		---/DCC
398	25	14		2	3	4				8	9		---/DCC
399	25	15	1	2	3	4				8	9		---/DCC
400	25	16					5			8	9		---/DCC
401	26	1	1				5			8	9		---/DCC
402	26	2		2			5			8	9		---/DCC
403	26	3	1	2			5			8	9		---/DCC
404	26	4			3		5			8	9		---/DCC
405	26	5	1		3		5			8	9		---/DCC
406	26	6		2	3		5			8	9		---/DCC
407	26	7	1	2	3		5			8	9		---/DCC
408	26	8				4	5			8	9		---/DCC
409	26	9	1			4	5			8	9		---/DCC
410	26	10		2		4	5			8	9		---/DCC
411	26	11	1	2		4	5			8	9		---/DCC
412	26	12			3	4	5			8	9		---/DCC
413	26	13	1		3	4	5			8	9		---/DCC

													
												10 (0/1)	
414	26	14			2	3	4	5			8	9	---/DCC
415	26	15	1	2	3	4	5				8	9	---/DCC
416	26	16						6			8	9	---/DCC
417	27	1	1					6			8	9	---/DCC
418	27	2		2				6			8	9	---/DCC
419	27	3	1	2				6			8	9	---/DCC
420	27	4				3		6			8	9	---/DCC
421	27	5	1			3		6			8	9	---/DCC
422	27	6		2	3			6			8	9	---/DCC
423	27	7	1	2	3			6			8	9	---/DCC
424	27	8					4	6			8	9	---/DCC
425	27	9	1				4	6			8	9	---/DCC
426	27	10		2			4	6			8	9	---/DCC
427	27	11	1	2			4	6			8	9	---/DCC
428	27	12			3	4		6			8	9	---/DCC
429	27	13	1		3	4		6			8	9	---/DCC
430	27	14		2	3	4		6			8	9	---/DCC
431	27	15	1	2	3	4		6			8	9	---/DCC
432	27	16						5	6		8	9	---/DCC
433	28	1	1					5	6		8	9	---/DCC
434	28	2		2				5	6		8	9	---/DCC
435	28	3	1	2				5	6		8	9	---/DCC
436	28	4				3		5	6		8	9	---/DCC
437	28	5	1			3		5	6		8	9	---/DCC
438	28	6		2	3			5	6		8	9	---/DCC
439	28	7	1	2	3			5	6		8	9	---/DCC

Key	Keyboard		ON										10 (0/1)
	0	1	1	2	3	4	5	6	7	8	9	0	
440	28	8				4	5	6		8	9	---	/DCC
441	28	9	1			4	5	6		8	9	---	/DCC
442	28	10		2		4	5	6		8	9	---	/DCC
443	28	11	1	2		4	5	6		8	9	---	/DCC
444	28	12			3	4	5	6		8	9	---	/DCC
445	28	13	1		3	4	5	6		8	9	---	/DCC
446	28	14		2	3	4	5	6		8	9	---	/DCC
447	28	15	1	2	3	4	5	6		8	9	---	/DCC
448	28	16							7	8	9	---	/DCC
449	29	1	1						7	8	9	---	/DCC
450	29	2		2					7	8	9	---	/DCC
451	29	3	1	2					7	8	9	---	/DCC
452	29	4			3				7	8	9	---	/DCC
453	29	5	1		3				7	8	9	---	/DCC
454	29	6		2	3				7	8	9	---	/DCC
455	29	7	1	2	3				7	8	9	---	/DCC
456	29	8				4			7	8	9	---	/DCC
457	29	9	1			4			7	8	9	---	/DCC
458	29	10		2		4			7	8	9	---	/DCC
459	29	11	1	2		4			7	8	9	---	/DCC
460	29	12			3	4			7	8	9	---	/DCC
461	29	13	1		3	4			7	8	9	---	/DCC
462	29	14		2	3	4			7	8	9	---	/DCC
463	29	15	1	2	3	4			7	8	9	---	/DCC
464	29	16					5		7	8	9	---	/DCC
465	30	1	1				5		7	8	9	---	/DCC

Key	Keyboard		ON										10 (0/1)					
	0	1	1	2	3	4	5	6	7	8	9	0						
466	30	2							2			5	7	8	9	---	/DCC	
467	30	3	1	2								5	7	8	9	---	/DCC	
468	30	4							3			5	7	8	9	---	/DCC	
469	30	5	1						3			5	7	8	9	---	/DCC	
470	30	6							2	3		5	7	8	9	---	/DCC	
471	30	7	1	2	3							5	7	8	9	---	/DCC	
472	30	8									4	5	7	8	9	---	/DCC	
473	30	9	1								4	5	7	8	9	---	/DCC	
474	30	10							2		4	5	7	8	9	---	/DCC	
475	30	11	1	2							4	5	7	8	9	---	/DCC	
476	30	12								3	4	5	7	8	9	---	/DCC	
477	30	13	1							3	4	5	7	8	9	---	/DCC	
478	30	14							2	3	4	5	7	8	9	---	/DCC	
479	30	15	1	2	3	4	5						7	8	9	---	/DCC	
480	30	16											6	7	8	9	---	/DCC
481	31	1	1										6	7	8	9	---	/DCC
482	31	2							2				6	7	8	9	---	/DCC
483	31	3	1	2									6	7	8	9	---	/DCC
484	31	4									3		6	7	8	9	---	/DCC
485	31	5	1								3		6	7	8	9	---	/DCC
486	31	6							2	3			6	7	8	9	---	/DCC
487	31	7	1	2	3								6	7	8	9	---	/DCC
488	31	8										4	6	7	8	9	---	/DCC
489	31	9	1									4	6	7	8	9	---	/DCC
490	31	10							2			4	6	7	8	9	---	/DCC
491	31	11	1	2							4		6	7	8	9	---	/DCC

												10 (0/1)
492	31	12			3	4		6	7	8	9	--- / DCC
493	31	13	1		3	4		6	7	8	9	--- / DCC
494	31	14		2	3	4		6	7	8	9	--- / DCC
495	31	15	1	2	3	4		6	7	8	9	--- / DCC
496	31	16					5	6	7	8	9	--- / DCC
497	32	1	1				5	6	7	8	9	--- / DCC
498	32	2		2			5	6	7	8	9	--- / DCC
499	32	3	1	2			5	6	7	8	9	--- / DCC
500	32	4			3		5	6	7	8	9	--- / DCC
501	32	5	1		3		5	6	7	8	9	--- / DCC
502	32	6		2	3		5	6	7	8	9	--- / DCC
503	32	7	1	2	3		5	6	7	8	9	--- / DCC
504	32	8				4	5	6	7	8	9	--- / DCC
505	32	9	1			4	5	6	7	8	9	--- / DCC
506	32	10		2		4	5	6	7	8	9	--- / DCC
507	32	11	1	2		4	5	6	7	8	9	--- / DCC
508	32	12			3	4	5	6	7	8	9	--- / DCC
509	32	13	1		3	4	5	6	7	8	9	--- / DCC
510	32	14		2	3	4	5	6	7	8	9	--- / DCC
511	32	15	1	2	3	4	5	6	7	8	9	--- / DCC

Adressen größer 511 können nur im DCC Format ausgegeben werden und müssen mit der CV Programmierung über das Programmiergleis durchgeführt werden.

Addresses larger than 511 can only be assigned in the DCC format and must be done by programming a CV using the programming track.

Les adresses supérieures à 511 peuvent uniquement être éditées dans le format DCC et doivent être exécutées avec la programmation des CV via la voie de programmation.

Adressen groter dan 511 kunnen alleen in het DCC formaat gebruikt worden en moeten met de CV programmering via het programmeerspoor ingesteld worden.

Las direcciones superiores a 511 pueden mostrarse en el formato DCC y deben configurarse con la función Programación de CVs mediante la vía de programación.

Indirizzi maggiori di 511 possono essere assegnati solo nel formato DCC e si devono eseguire con la programmazione delle CV tramite il binario di programmazione.

Adresser överstigande 511 kan endast skrivas in i DCC-format och måste göras med CV-programmering med loket på programmeringspåret.

Adresser højere end 511 kan kun udtrykkes i DCC format og skal udføres med CV programmeringen via programmeringsporet.

Aufbau • Setup • Montage • Opbouwen • Montaje • Montaggio • Montering • Forsamling

Kabelfarben

- 1 rot / red / rouge / rood / rojo /
rosso / röd / rød
- 2 braun / brown / brun / bruin / marrón /
marrone / brun / brun
- 3 gelb / yellow / jaune / geel / amarillo /
giallo / gul / gul
- 4 violett / violett / violet /
paars / violeta / viola /
violett / violet
- 5 rot-braun / red-brown / rouge-brun /
rood-bruin / rojo-marrón / rosso-marrone /
röd-brun / rød-brun
- 6 rot-grün / red-green / rouge-vert / rood-groen /
rojo-verde / rosso-verde / röd-grön / rød-grøn

Anschluss Programmiergleis

Connections for the Programming Track

Branchement voie de programmation

Aansluiten op het programmeerspoor

Conexión de la vía de programación

Collegamento del binario di programmazione

Isolamento e connessioni della tratta del segnale

Anslutning till programmeringsspåret

Tilslutning programmeringsskinne

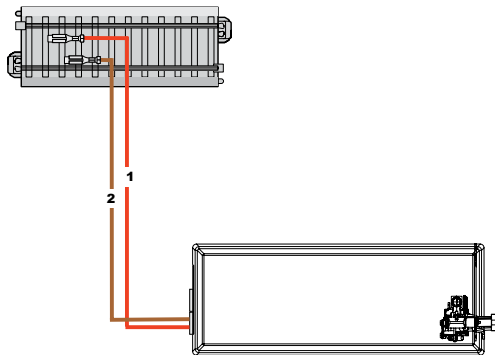

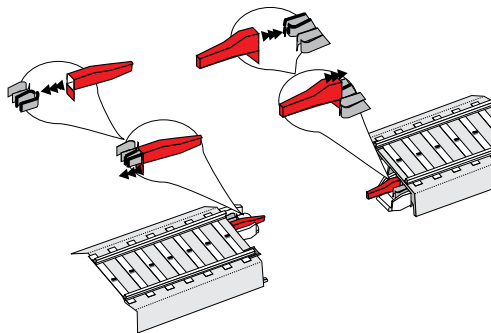
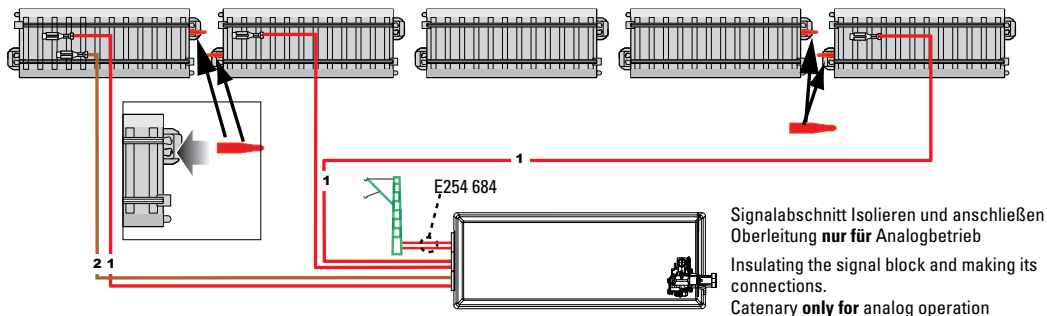

Isoler la partie du signal et brancher
Caténaire **seulement pour** exploitation analogique

Stopsectie isoleren en aansluiten
Bovenleiding **alleen in** analoogbedrijf

Aislamiento y conexión del tramo de señal
corriente por catenaria **solo modo** analógico

Conexión de la vía de programación
Catenaria **solo per la** modalità analogica

Isolering av och anslutning av ett spåravsnitt
Kontaktledning **bara för** analogt läge

Isolér og tilslut signalafsnit
Køreledninger **kun for** analog tilstand

Befestigung am C-Gleis
Installation with C Track
Fixation à la voie C
Bevestiging aan C-rail
Sujeción a la vía K
Fissaggio al binario C
Fastsättning vid C-räls
Fastgørelse på C-skinne

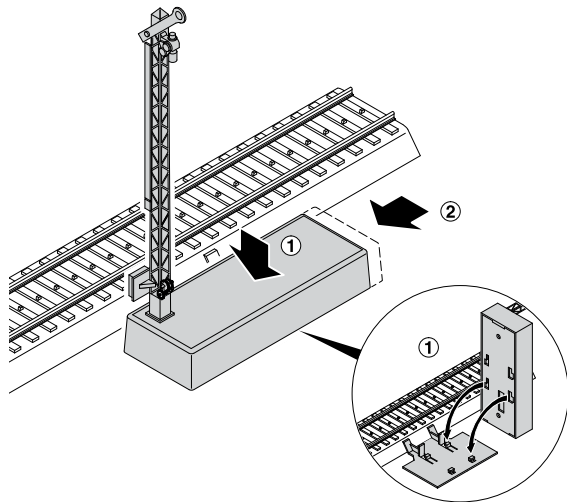
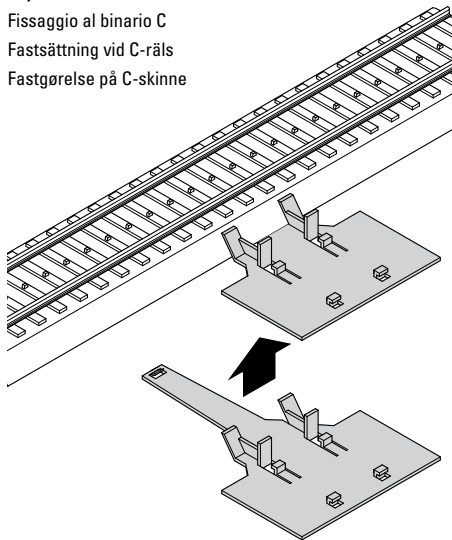

Befestigung am K-Gleis oder anderen Gleissystemen
Installation with K Track or Other Track Systems
Fixation à la voie K ou à d'autres systèmes de voies
Befestiging aan K-rail of ander railsysteem
Sujeción a la vía K u a otros sistemas de vías
Fissaggio al binario K oppure altri sistemi di binario
Fastsättning vid K-räls eller andra rälsystemer
Fastgørelse på K-skinne eller andre skinneresystemer

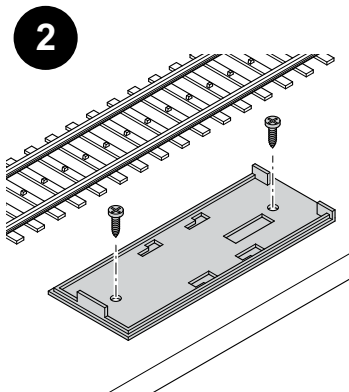
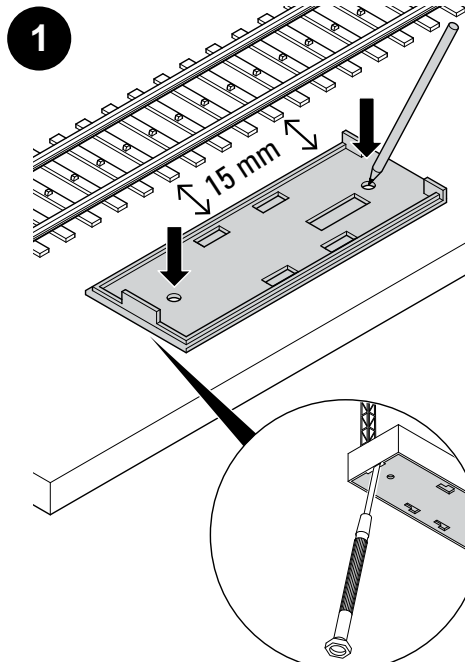

Mit beiliegender Bohrschablone markieren.
Mark with the template included with the signal.
Marquer avec le patron de perçage ci-joint.
Met meegeleverde sjabloon markeren
Marcar con la plantilla de taladros adjunta.
Marcare con l'acclusa maschera di foratura.
Markera med hjälp av medföljande borrhäblon
Markér med vedlagte boreskabelon.

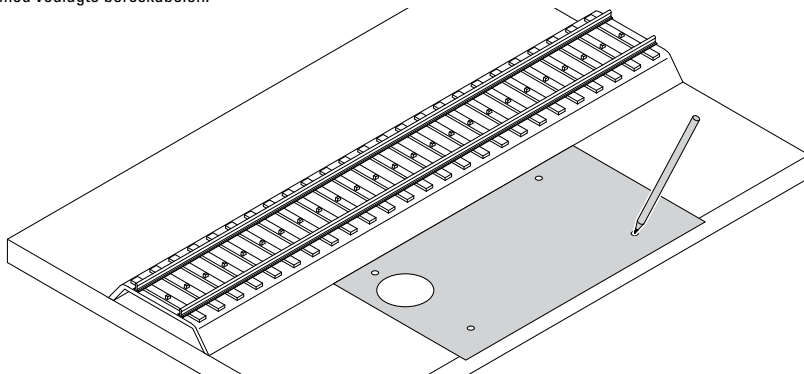

Steckteile entfernen

Remove detail parts.

Ôter les connecteurs

Opsteekdelen verwijderen

Desmontaje de las piezas enchufables

Rimuovere gli elementi a innesto

Avlägsna insticksdelar

Fjern stikdele

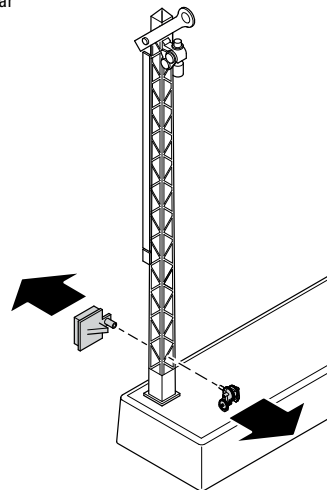
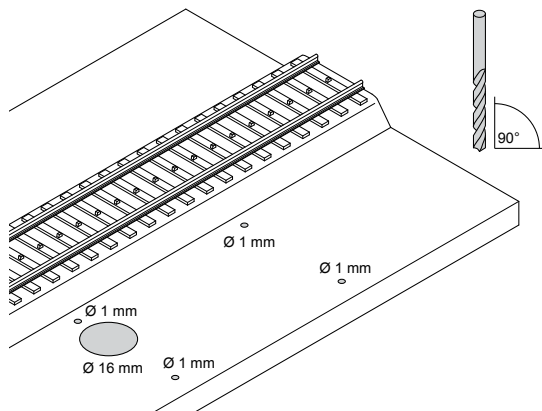

Unterflurmontage:

Below-Baseboard Installation:

Montage souterrain :

Ondervloermontage:

Montaje bajo el suelo:

Montaggio sotto plancia:

Montage under anläggningen

Underhængt montering:

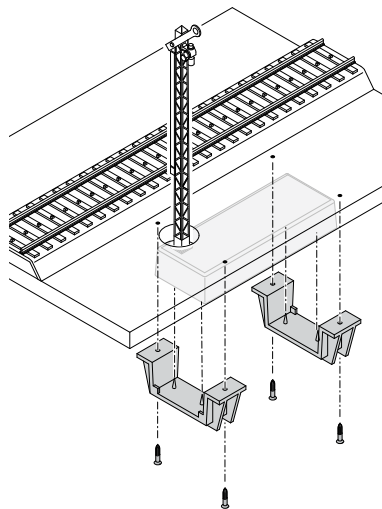
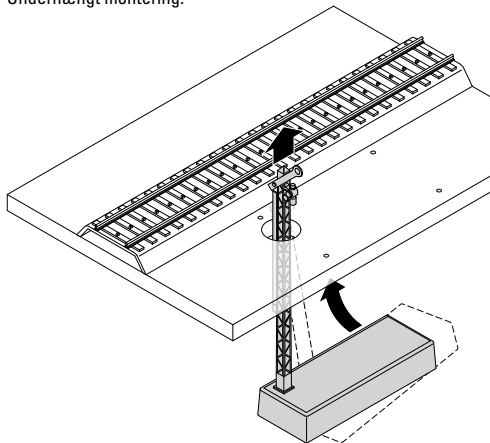

Abdeckung anbringen

Install the cover.

Poser le couvercle

Afdekking aanbrengen

Colocar la cubierta

Applicare il coperchio

Sätt på locket

Anbring afdækning

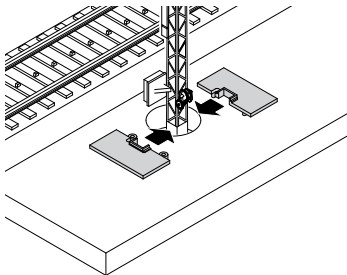

Steckteile nach erfolgter Unterflurmontage wieder anbringen.

Reinstall detail parts after completing below-baseboard installation.

Remonter les connecteurs après le montage souterrain.

Opsteekdelen na succesvolle ondervloermontage weer aanbrengen.

Colocar de nuevo las piezas enchufables una vez realizado el montaje bajo el suelo

Applicare di nuovo gli elementi a innesto dopo avvenuto montaggio sotto plancia.

Efter montage av signalen under anläggningen sätts insticksdelarna tillbaka

Anbring stikdele efter gennemført underhængt montering.

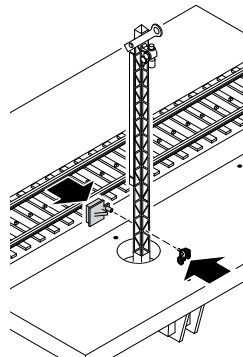

Anschluss Bremsmodul 72441/72442

Connections for the 72441/72442 Braking Module

Branchement module de freinage 72441/72442

Aansluiten afremmodule 72441/72442

Conexión del módulo de frenado 72441/72442

Conessioni del modulo di frenatura 72441/72442

Anslutning av bromsmodul 72441/72442

Tilslutning bromsemodul 72441/72442

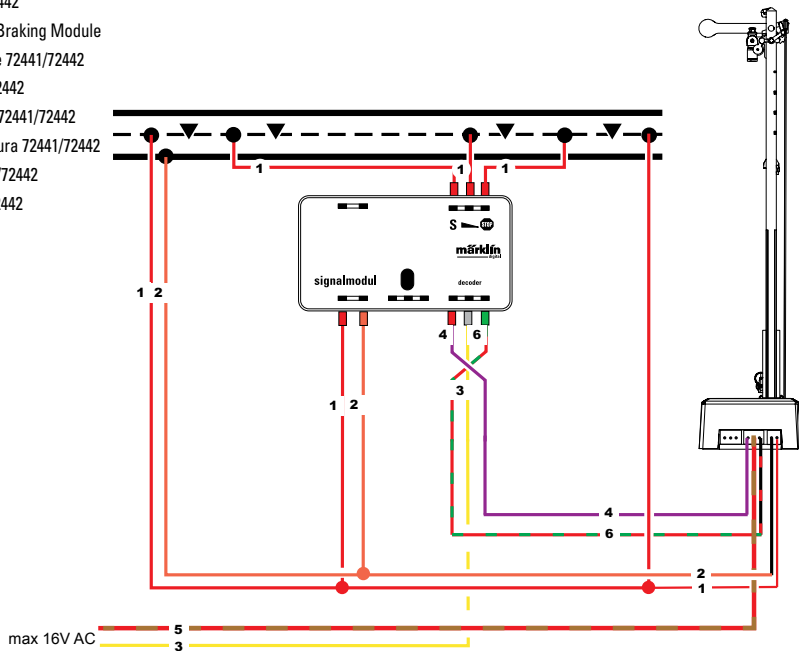

**Aufkleber anbringen • Attach decals • Fixez les autocollants • Bevestig stickers •
 Allega decalcomanie • Coloque las calcomanías • Bifoga dekaler • Vedhæft decals**

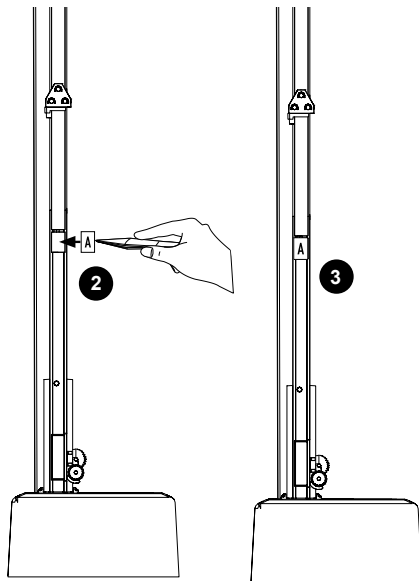
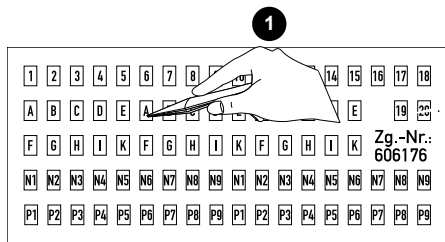

**Bohrschablone • Drilling Template • Gabarit de perçage • Boorsjabloon •
Plantilla • Maschera di Foratura • Borrshablon • Boreskabelon**

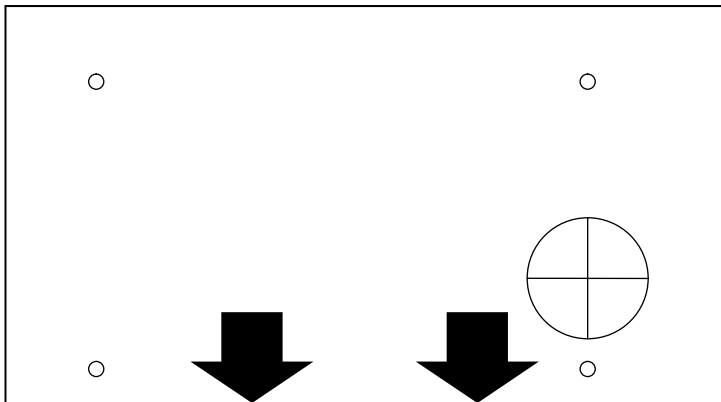

Due to different legal requirements regarding electro-magnetic compatibility, this item may be used in the USA only after separate certification for FCC compliance and an adjustment if necessary.

Use in the USA without this certification is not permitted and absolves us of any liability. If you should want such certification to be done, please contact us – also due to the additional costs incurred for this.

Gebr. Märklin & Cie. GmbH
Stuttgarter Straße 55 - 57
73033 Göppingen
Germany
www.maerklin.com



www.maerklin.com/en/imprint.html

236105/0116/Sc6Pw
Änderungen vorbehalten
© Gebr. Märklin & Cie. GmbH